



Ghaem Trading CO with more than 25 years of brilliant experience in the field of importing cabinet and construction hardware ; has imported a wide range of goods in this industry relying on knowledge and experience during these years. Iranian and zone market knowledge and analysis and the importance of self-sufficiency have been important reasons to start production ; for this purpose Ghaem industrial group was established in 2012.

In this regard, using the world's latest methods, brainy designers, experienced and creative human resources, as well as observing all standards and laws of environment, health and safety, have been lead us to produce high quality products.

بازرگانی قائم با بیش از ۲۵ سال سابقه درخشان در زمینه واردات یراق کابینت و ساختمانی ، تجربه ای ارزشمند کسب نموده است. و طی این سالها با اتکا به دانش و تجربه، طیف گسترده ای از کالاهای این صنعت را وارد نموده است شناخت بازار ایران و منطقه و اهمیت خودکفایی دلایل مهمی جهت آغاز تولید بود و بدین منظور گروه صنعتی قائم در سال ۱۳۹۱ تاسیس گردید در این راستا با به کارگیری جدیدترین متدهای روز دنیا ، طراحان خوش فکر، نیروهای کارآزموده و خلاق ، رعایت تمامی استانداردها و قوانین محیط زیست و بهداشت و ایمنی توانسته ایم محصولات با کیفیت تولید بنماییم

Distiction Of The Complex •—————• وجوه تمایز مجموعه

- 1.Enriching the product portfolio and meet all levels of customer needs
- 2.Utilizing the latest technology of this industry to produce high quality products
- 3.Utilizing the best raw materials and quality control.
- 4.Customer focused and efforts to involve the customer in the design and production process.
- 5.Providing products with two registered brands of this complex, according to the market demand in order to cover different levels of the market:
 - NICE: High quality and luxury goods
 - BARBOD: high quality goods with reasonable prices
6. Free delivery of products:
Tehran, delivery at the customer's store .
Other cities, delivery in freight

- ۱.غنی سازی سبد کالا و برطرف نمودن تمامی سطوح نیاز مشتری
۲. بهره گیری از آخرین تکنولوژی مربوط به این صنعت جهت خلق محصولات باکیفیت
۳. بهره گیری از مرغوبترین مواد اولیه و کنترل کیفی
۴. مشتری مداری و تلاش برای شریک نمودن مشتری در فرآیند طراحی و تولید
۵. ارائه محصولات با دو برند ثبتی این مجموعه با توجه به درخواست بازار به منظور پوشش سطوح مختلف بازار
 - نایس: کالاهای با کیفیت و لوکس
 - باربد: کالاهای باکیفیت و قیمت مناسب
۶. ارسال رایگان کالا: درتهران تحویل در فروشگاه مشتری و در شهرستانها تحویل در باربری

1. With respect to consumer rights, the management and staff of this group, aim to achieve the highest quality in this industry.
2. Achieving the regional market : for this purpose ,exports to neighboring countries are considered , which will cause more employment for our country's youth.
3. Cooperation with related industries in order to produce new products to accept orders from wood and MDF factories.
4. Assisting small production units to improve their business in this area.
5. Cooperation with mass constructors to provide cabinet and construction hardware.

۱. مدیریت و کارکنان این مجموعه با احترام به حقوق مصرف کننده، دستیابی به بالاترین درجه کیفیت را در این صنعت هدف خود قرار داده است
۲. دستیابی به بازار منطقه: در این راستا صادرات به کشورهای همسایه مدنظر است که باعث اشتغال بیشتر جوانان کشورمان می گردد
۳. همکاری با صنایع مرتبط جهت تولید محصولات جدید و قبول سفارشات کارخانه های صنایع چوبی و ام دی اف
۴. کمک به واحدهای تولیدی کوچک جهت بهتر شدن کسب و کارشان در این عرصه
۵. همکاری با انبوه سازان جهت تهیه یراق آلات کابینت و ساختمانی.

In order to improve the quality of its products, Ghaem Trading has established a specialized laboratory related to component tests, and different tests are constantly taken from the manufactured components.

The very high importance of the coating (anodize plating, powder paint) caused that, in addition to the Nice laboratory, salt spray tests were also performed by the Razi Applied Sciences Foundation.

Receiving these certificates is an emphasis on the transparency and honesty of Nice with customers. Since the quality is endless, in addition to maintaining quality, the company tries to constantly increase the quality level of its activities.

بازرگانی قائم جهت ارتقاء کیفیت محصولات خود، آزمایشگاه تخصصی مربوط به تست‌های قطعات را تاسیس نموده و دائماً تست‌های متفاوتی از قطعات تولید شده گرفته میشود.

اهمیت بسیار بالای پوشش یراق (آبکاری آنودایز، رنگ پودری) موجب شد که علاوه بر آزمایشگاه نایس، تست‌های نمک پاشی توسط بنیاد علوم کاربردی رازی نیز انجام پذیرد

دریافت این گواهینامه‌ها تاکیدی بر شفافیت و صداقت نایس با مشتریان است

از آنجایی که کیفیت بی پایان است، شرکت علاوه بر حفظ کیفیت، می‌کوشد به طور دائمی سطح کیفیت فعالیت‌های خود را افزایش دهد

- گواهینامه تست نمک پاشی بر روی دستگیره های کابینتی زاماک و آلومینیومی نایس
- گواهینامه تست نمک پاشی بر روی پروفیل های دکوراتیو آلومینیومی نایس

KATI METALLURGICAL RESEARCH CENTER TEST REPORT

Customer Name: Mideh Foundation
 Customer Address: No. 432, Ave. 19th N. Shahr-e Khatemeh Bk. Fardis
 Sample Name: Sample of Zamak handle
 Class Reference Number: Laboratory Environmental Conditions
 Test was performed under the scope of ISO/IEC 17025 standard

Done At: Tehran
 Issue No.: 4
 Revision No.: 0
 Sampling Record of: 001/192/191
 Date of Report Printing: 001/192/191
 Issuing End Date: 001/192/197
 Page: 1 of 3

Salt Spray Test
 According to: ASTM B117-19

Result of salt spray test:
 NaCl Concentration: 5.11 NaCl percent NaCl/H₂O
 Pressure: 0.83 ± 0.28 bar
 Cleaning method prior test: Running Water
 Position of specimen during test: 15°-30° from the Vertical Position

Temp: 35±1 °C
 pH range: 6.5-7.2
 Spray time: 90 hr
 No. of sample: 3

Inspection Time (h)	Description
24	No sign of corrosion was observed on the surface of the sample.
48	No change was observed.
72	No change was observed.
96	White rust appeared in some points of surface.

Sh. Rajabi
 Sh. Rajabi
 M. Jafarian

KATI METALLURGICAL RESEARCH CENTER TEST REPORT

Customer Name: Mideh Foundation
 Customer Address: No. 432, Ave. 19th N. Shahr-e Khatemeh Bk. Fardis
 Sample Name: Sample of aluminum handle
 Class Reference Number: Laboratory Environmental Conditions
 Test was performed under the scope of ISO/IEC 17025 standard

Done At: Tehran
 Issue No.: 4
 Revision No.: 0
 Sampling Record of: 001/192/191
 Date of Report Printing: 001/192/191
 Issuing End Date: 001/192/197
 Page: 1 of 3

Salt Spray Test
 According to: ASTM B117-19

Result of salt spray test:
 NaCl Concentration: 5.11 NaCl percent NaCl/H₂O
 Pressure: 0.83 ± 0.28 bar
 Cleaning method prior test: Running Water
 Position of specimen during test: 15°-30° from the Vertical Position

Temp: 35±1 °C
 pH range: 6.5-7.2
 Spray time: 90 hr
 No. of sample: 3

Inspection Time (h)	Description
24	White rust appeared in 1, 2 points of the surface.

Sh. Rajabi
 Sh. Rajabi
 M. Jafarian

گواهینامه تست نمک پاشی
 (Salt Spray) تست بر روی دستگیره های کابینتی زاماک و آلومینیومی نایس

موسسه تحقیقات فلزی کاتی
 KATI METALLURGICAL RESEARCH CENTER

مشخصات کلی: نام مشتری: میده فاندیشن، آدرس: تهران، خیابان ۱۹م شمالی، پلاک ۴۳۲، مجتمع تجاری فاردیس، طبقه ۴، واحد ۴۰۹

مشخصات تست: استاندارد: ASTM B117-19، دما: ۳۵±۱ درجه سانتیگراد، pH: ۶.۵ تا ۷.۲، فشار: ۰.۸۳±۰.۲۸ بار، زمان پاشی: ۹۰ ساعت، تعداد نمونه: ۳

زمان مشاهده (ساعت)	توصیف
۲۴	هیچ نشانه خوردگی مشاهده نشد.
۴۸	تغییر مشاهده نشد.
۷۲	تغییر مشاهده نشد.
۹۶	تغییر مشاهده نشد.
۱۲۰	تغییر مشاهده نشد.
۱۴۴	تغییر مشاهده نشد.
۱۶۸	تغییر مشاهده نشد.
۱۹۲	تغییر مشاهده نشد.

مهر و امضای مسئول آزمایشگاه: م. جعفریان



...

Cabinet Handles

Focus on Quality

...

Cabinet handles colour



MAB
زیتونی



PVD
طلایی براق



CP
کروم براق

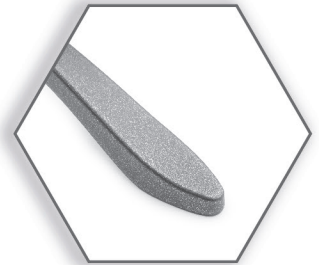

D.Gray
طوسی



SW
دودی براق



Black
مشکی

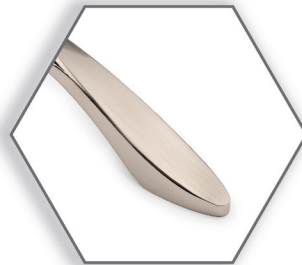

SN
کروم مات

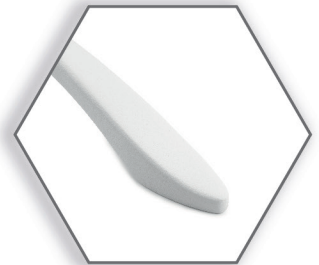

White
سفید



GP
طلایی براق



SG
طلایی مات

Cabinet Handle

N138

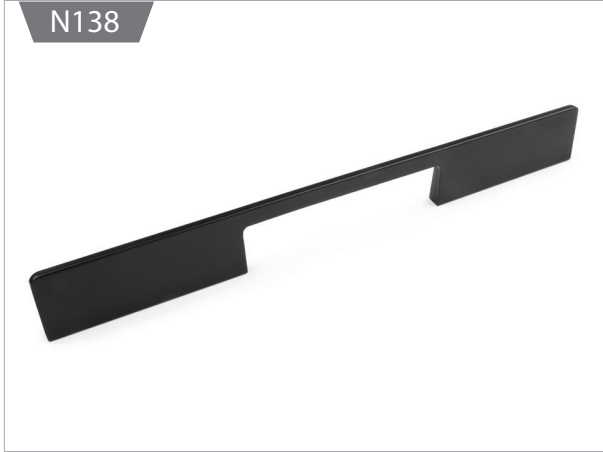

Aluminium

size (mm) سایز	L (mm) طول کلی	Weight (gr) وزن
160	220	73
224	284	107
320	380	156
512	572	250
640	700	325
768	828	385

Multi Colour

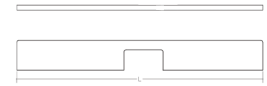

N139



Aluminium

size (mm) سایز	L (mm) طول کلی	Weight (gr) وزن
160	220	106
224	284	152
320	380	218
512	572	353
640	700	447
768	828	538

Multi Colour



N143



Aluminium

size (mm) سایز	L (mm) طول کلی	Weight (gr) وزن
160	220	97
224	284	125
288	348	155
352	412	184
416	476	212

Multi Colour



www.nicehwn.com

Cabinet Handle

N138B

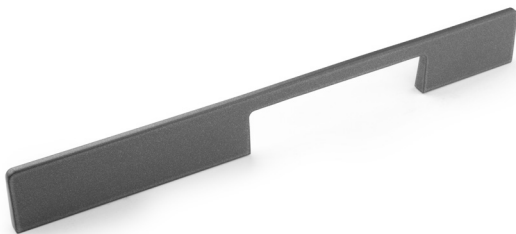

Aluminium

size (mm) سایز	L (mm) طول کلی	Weight (gr) وزن
160	220	73
224	284	107
320	380	156
512	572	250
640	700	325
768	828	385

Multi Colour



N139B



Aluminium

size (mm) سایز	L (mm) طول کلی	Weight (gr) وزن
160	220	106
224	284	152
320	380	218
512	572	353
640	700	447
768	828	538

Multi Colour



N143B

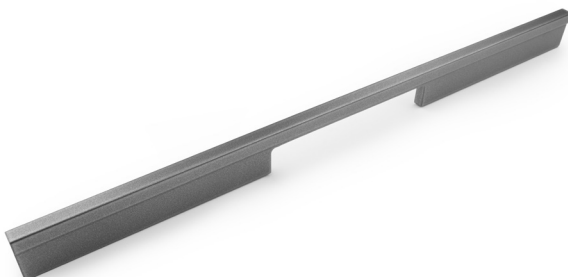

Aluminium

size (mm) سایز	L (mm) طول کلی	Weight (gr) وزن
320	380	192
480	540	291
640	700	372
800	760	489
900	1020	588

Multi Colour



Cabinet Handle

N146B



Aluminium

size (mm) سایز	L (mm) طول کلی	Weight (gr) وزن
320	410	215
480	570	299
640	730	382
800	890	466
900	990	518

Multi Colour



11

www.nicehw.com

N131



Aluminium

size (mm) سایز	L (mm) طول کلی	Weight (gr) وزن
96	128	53
128	160	66
160	192	79
288	352	144
416	480	196
544	608	249
672	736	301
800	864	353

Multi Colour



Cabinet Handle

N250



Zamak-Aluminium

size (mm) سایز	L (mm) طول کلی	Weight (gr) وزن
160	190	114
224	254	152
288	318	190
352	382	228
416	446	289

Multi Colour

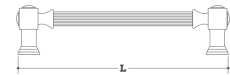

N251



Zamak-Aluminium

size (mm) سایز	L (mm) طول کلی	Weight (gr) وزن
160	190	126
224	254	168
288	318	210
352	382	252
416	446	295

Multi Colour

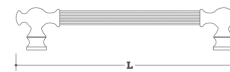

N257



Zamak-Aluminium

size (mm) سایز	L (mm) طول کلی	Weight (gr) وزن
K	50	29
128	178	80
192	242	99
256	306	118
320	370	137
384	434	156

Multi Colour



Cabinet Handle

N254



Zamak-Aluminium

size (mm) سایز	L (mm) طول کلی	Weight (gr) وزن
160	190	114
224	254	152
288	318	190
352	382	228
416	446	289

Multi Colour



N255



Zamak-Steel

size (mm) سایز	L (mm) طول کلی	Weight (gr) وزن
160	190	126
224	254	168
288	318	210
352	382	252
416	446	295

Multi Colour



N256



Zamak-Steel

size (mm) سایز	L (mm) طول کلی	Weight (gr) وزن
160	190	114
224	254	152
288	318	190
352	382	228
416	446	289

Multi Colour

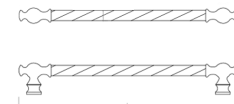

Cabinet Handle

N151



Zamak

size (mm) سایز	L (mm) طول کلی	Weight (gr) وزن
128	144	135
192	208	171
256	272	205



N142



Zamak

size (mm) سایز	L (mm) طول کلی	Weight (gr) وزن
160	260	90
192	317	112
224	368	150

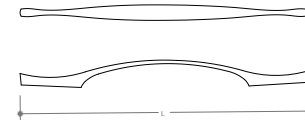

N118



Zamak

size (mm) سایز	L (mm) طول کلی	Weight (gr) وزن
160	208	103
224	271	143
288	336	175

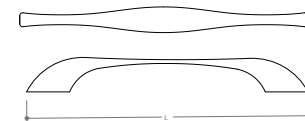

Cabinet Handle

N140



Zamak

size (mm) سایز	L (mm) طول کلی	Weight (gr) وزن
160	176	100
224	240	132
320	337	159

Multi Colour



N141



Zamak

size (mm) سایز	L (mm) طول کلی	Weight (gr) وزن
160	176	112
224	240	143
320	337	180

Multi Colour

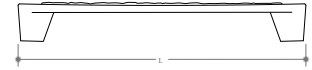

N132



Aluminium

size (mm) سایز	L (mm) طول کلی	Weight (gr) وزن
160	173	47
224	236	68
320	331	92

Multi Colour

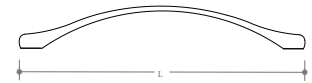
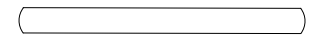

Cabinet Handle

N144



Aluminium

size (mm) سایز	L (mm) طول کلی	Weight (gr) وزن
128	172	42
192	236	62
256	300	73

Multi Colour

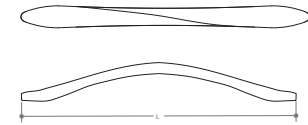

N147



Aluminium

size (mm) سایز	L (mm) طول کلی	Weight (gr) وزن
192	211	91
256	274	129
320	338	147

Multi Colour

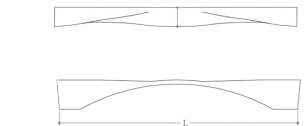

N148



Aluminium

size (mm) سایز	L (mm) طول کلی	Weight (gr) وزن
192	211	100
256	274	131
320	338	155

Multi Colour

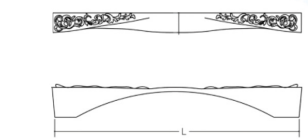

Cabinet Handle

N112



Aluminium

size (mm) سایز	L (mm) طول کلی	Weight (gr) وزن
192	200	64
256	256	79
320	328	102

Multi Colour

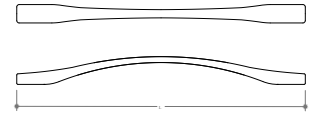

N150



Aluminium

size (mm) سایز	L (mm) طول کلی	Weight (gr) وزن
128	151	60
192	215	78
256	275	94

Multi Colour

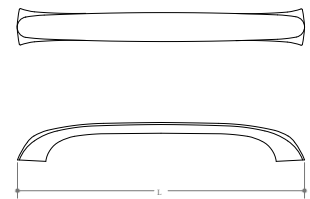

N135



Zamak

size (mm) سایز	L (mm) طول کلی	Weight (gr) وزن
160	167	89
224	231	115
288	295	132

Multi Colour

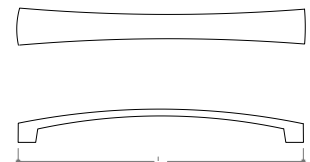

Cabinet Handle

N145



Aluminium

size (mm) سایز	L (mm) طول کلی	Weight (gr) وزن
160	220	52
256	340	89
192-320	478	136

Multi Colour

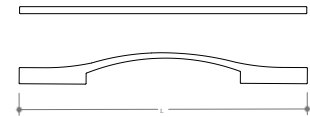

N156



Aluminium

size (mm) سایز	L (mm) طول کلی	Weight (gr) وزن
128	170	48
160	205	55
192	235	63
224	270	66

Multi Colour

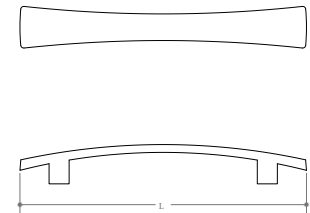

N114



Aluminium

size (mm) سایز	L (mm) طول کلی	Weight (gr) وزن
128	145	38
192	211	48
256	276	59

Multi Colour

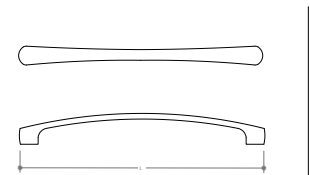

Cabinet Handle

N133

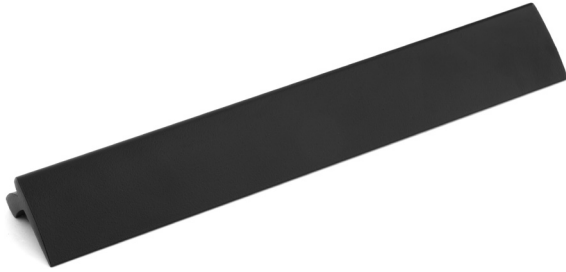

Aluminium

size (mm) سایز	L (mm) طول کلی	Weight (gr) وزن
96	128	72
128	160	87
160	192	107

Multi Colour

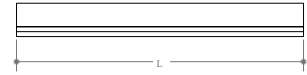

N134



Aluminium

size (mm) سایز	L (mm) طول کلی	Weight (gr) وزن
160	190	120
224	254	168
288	318	216

Multi Colour

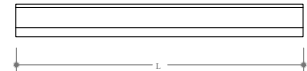
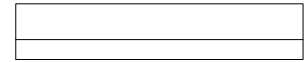

N157



Aluminium

size (mm) سایز	L (mm) طول کلی	Weight (gr) وزن
96	130	23.6
128	160	31.6
160	190	34

Multi Colour

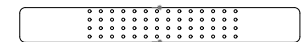

Cabinet Handle

N136



Zamak

size (mm) سایز	L (mm) طول کلی	Weight (gr) وزن
96	130	23.6
128	160	31.6

Multi Colour

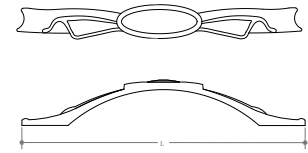

N137

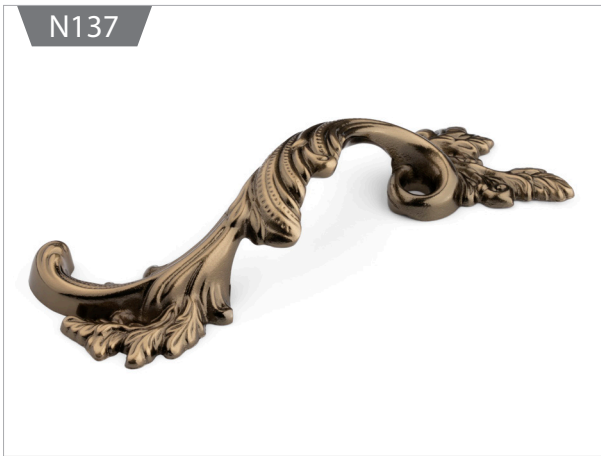

Zamak

size (mm) سایز	L (mm) طول کلی	Weight (gr) وزن
64	102	39
96	142	81

Multi Colour

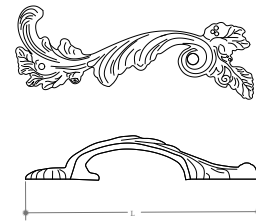

N201



Aluminium

size (mm) سایز	L (mm) طول کلی	Weight (gr) وزن
96	117	42
128	148	48

Multi Colour

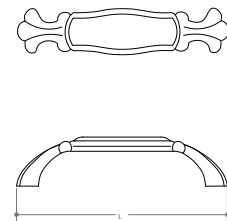

Cabinet Handel

N303



Aluminium

size (mm) سایز	L (mm) طول کلی	Weight (gr) وزن
150	150	86
200	200	105
250	250	126
300	300	147
400	400	188

Multi Colour

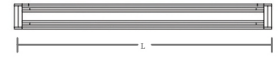
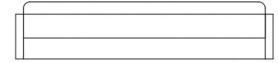

N304



Aluminium

size (mm) سایز	L (mm) طول کلی	Weight (gr) وزن
64	85	29

Multi Colour

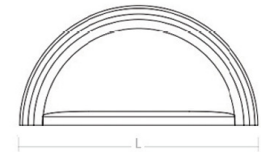

N305



Aluminium

size (mm) سایز	L (mm) طول کلی	Weight (gr) وزن
96	113	57.5

Multi Colour

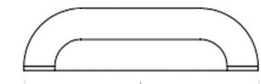

Cabinet Handle

N400



Aluminium

L (mm) طول کلی	H (mm) ارتفاع	Weight (gr) وزن
96	36	26
128	36	36
160	36	44

Multi Colour

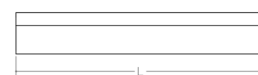

N402



Aluminium

L (mm) طول کلی	H (mm) ارتفاع	Weight (gr) وزن
96	36	25
128	36	33
160	36	41

Multi Colour



N404



Aluminium

L (mm) طول کلی	H (mm) ارتفاع	Weight (gr) وزن
96	39	35
128	39	46
160	39	58

Multi Colour



Cabinet Handle

N401

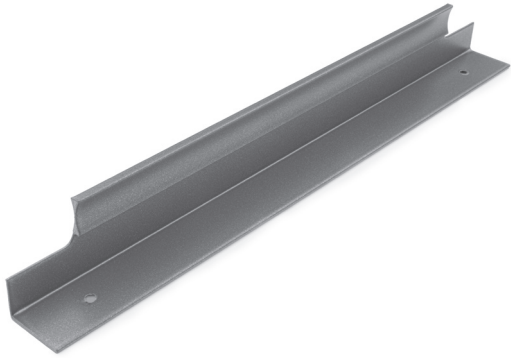

Aluminium

L (mm) طول کلی	Weight (gr) وزن
150	35
300	77
450	105
600	146
700	180
900	228

Multi Colour

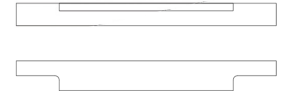

N403



Aluminium

L (mm) طول کلی	Weight (gr) وزن
150	32
300	70
450	100
600	137
700	170
900	227

Multi Colour



N405



Aluminium

L (mm) طول کلی	Weight (gr) وزن
300	91
450	131
600	182
700	221
900	275

Multi Colour





Knob Handles

Focus on Quality

Knob Handle

N121



Zamak

size (mm) سایز	H (mm) ارتفاع	L (mm) طول	W (mm) عرض	Weight (gr) وزن
K	24	38	38	50

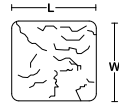
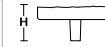

N122



Zamak

size (mm) سایز	H (mm) ارتفاع	L (mm) طول	W (mm) عرض	Weight (gr) وزن
K	20	33	33	32

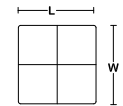
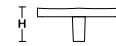

N123



Aluminium

size (mm) سایز	H (mm) ارتفاع	D (mm) قطر	Weight (gr) وزن
K	20	30	12

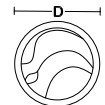
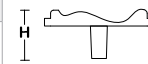

Knob Handle

N124



Multi Colour



Zamak

size (mm) سایز	H (mm) ارتفاع	D (mm) قطر	Weight (gr) وزن
K	23	32	45

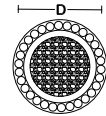
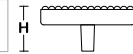

N125

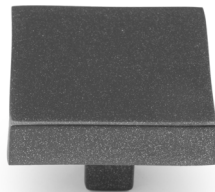

Multi Colour



Aluminium

size (mm) سایز	H (mm) ارتفاع	L (mm) طول	W (mm) عرض	Weight (gr) وزن
K	24	35	35	18

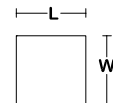
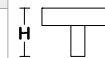

N127



Multi Colour



Aluminium

size (mm) سایز	H (mm) ارتفاع	D (mm) قطر	Weight (gr) وزن
K	24	34.5	13

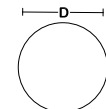
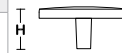

Knob Handle

N128



Multi Colour

Zamak

size (mm) سایز	H (mm) ارتفاع	D (mm) قطر	Weight (gr) وزن
K	21	36	106

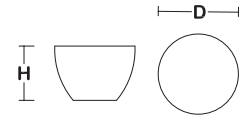

N129



Multi Colour

Zamak

size (mm) سایز	H (mm) ارتفاع	D (mm) قطر	Weight (gr) وزن
K	30	31	52

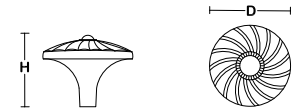

N160

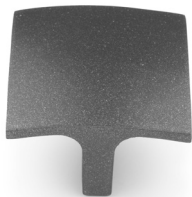

Multi Colour

Aluminium

size (mm) سایز	H (mm) ارتفاع	D (mm) قطر	Weight (gr) وزن
32	24	40	25

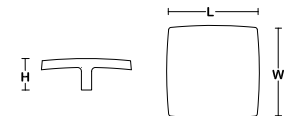

Knob Handle

N161



Aluminium

size (mm) سایز	H (mm) ارتفاع	L (mm) طول	W (mm) عرض	Weight (gr) وزن
K	16	44	20	16



N182



Aluminium

size (mm) سایز	H (mm) ارتفاع	D (mm) قطر	Weight (gr) وزن
K	27	30	28

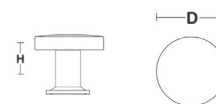

N162



Aluminium

size (mm) سایز	H (mm) ارتفاع	L (mm) طول	Weight (gr) وزن
32	25	59	123

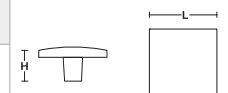

Knob Handle

N190



Aluminium

size (mm) سایز	H (mm) ارتفاع	L (mm) طول	W (mm) عرض	Weight (gr) وزن
K	28	33	33	19

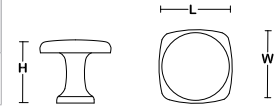

N300



Aluminium

size (mm) سایز	H (mm) ارتفاع	L (mm) طول	W (mm) عرض	Weight (gr) وزن
K	11	35	41	17

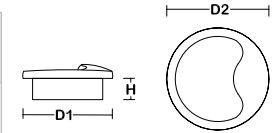

N301



Aluminium

size (mm) سایز	H (mm) ارتفاع	L (mm) طول	W (mm) عرض	Weight (gr) وزن
K	11	35	44	22

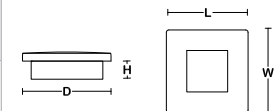

Knob Handle

N172



Aluminium

size (mm) سایز	H (mm) ارتفاع	D (mm) قطر	Weight (gr) وزن
K	27	30	25

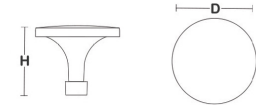

N175



Aluminium

size (mm) سایز	H (mm) ارتفاع	D (mm) قطر	Weight (gr) وزن
K	22	30	18

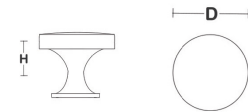

N126



Aluminium

size (mm) سایز	H (mm) ارتفاع	D (mm) قطر	Weight (gr) وزن
K	22	30	11



Knob Handle

N179



Multi Colour



Aluminium

size (mm) سایز	H (mm) ارتفاع	D (mm) قطر
K	22	30

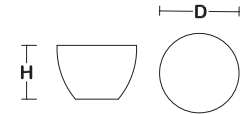

31

www.nicehw.com

N275K



Multi Colour



size (mm) سایز	H (mm) ارتفاع	L (mm) طول	D (mm) قطر
K	3.4	50	12



Door Handles
Focus on Quality

Door Handle

N901



Zamak

L (mm) طول	D (mm) قطر	Weight (gr) وزن
142	52	1147

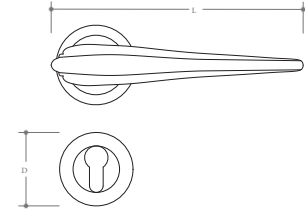

N902



Zamak

L (mm) طول	D (mm) قطر	Weight (gr) وزن
142	52	1190

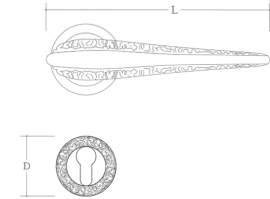

N903

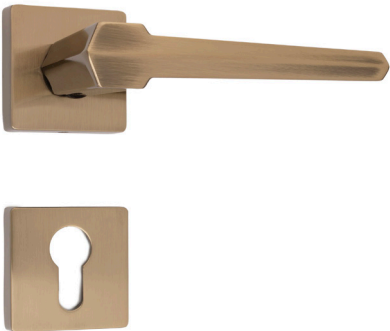

Zamak

L (mm) طول	D (mm) قطر	Weight (gr) وزن
135	51	1147

Door Handle

N904



Multi Colour

Zamak

L (mm) طول	D (mm) قطر	Weight (gr) وزن
133	52	867

N905



Multi Colour

Zamak

L (mm) طول	D (mm) قطر	Weight (gr) وزن
134	51	1097

N906

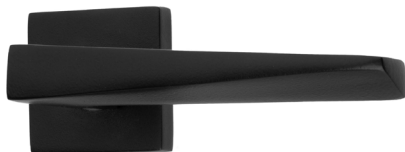

Multi Colour

Zamak

L (mm) طول	D (mm) قطر	Weight (gr) وزن
130	51	1160

Door Handle

N907



Zamak

L (mm) طول	D (mm) قطر	Weight (gr) وزن
130	52	970

N908



Zamak

L (mm) طول	D (mm) قطر	Weight (gr) وزن
135	52	910

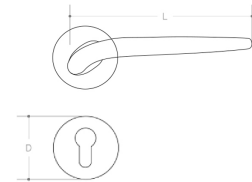

N909



Zamak

L (mm) طول	D (mm) قطر	Weight (gr) وزن
130	51	619

Door Handle

N910



Zamak

L (mm) طول	D (mm) قطر	Weight (gr) وزن
140	51	984



Zamak

L (mm) طول	D (mm) قطر	Weight (gr) وزن
-	-	-



Zamak

L (mm) طول	D (mm) قطر	Weight (gr) وزن
-	-	-

Door Handle

N801



Aluminium

L (mm) طول	D (mm) قطر	Weight (gr) وزن
142	52	702

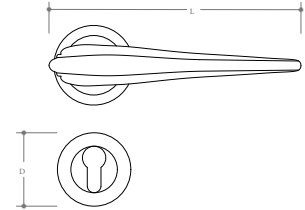

N802



Aluminium

L (mm) طول	D (mm) قطر	Weight (gr) وزن
142	52	722

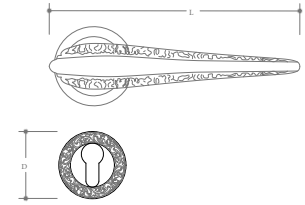

N803



Aluminium

L (mm) طول	D (mm) قطر	Weight (gr) وزن
130	51	450

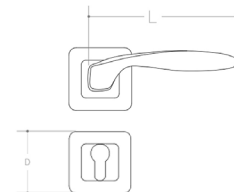

Door Handle

N805



Aluminium

L (mm) طول	D (mm) قطر	Weight (gr) وزن
128	51	464

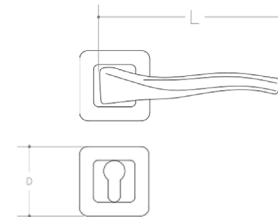

N806

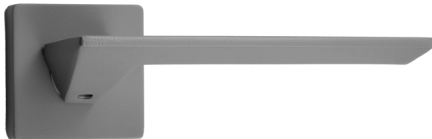

Aluminium

L (mm) طول	D (mm) قطر	Weight (gr) وزن
132	51	396

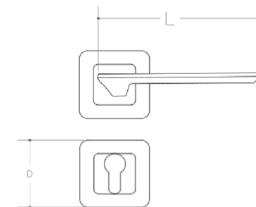

N808



Aluminium

L (mm) طول	D (mm) قطر	Weight (gr) وزن
135	52	500

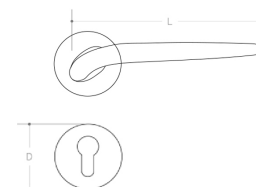

Door Handle

N703



Multi Colour

Zamak

L1 (mm) طول کلی	L (mm) آکس سوراخ	W1 (mm) عرض دستگیره	W2 (mm) طول دستگیره	Weight (gr) وزن
255	219	48	135	1365

N704



Multi Colour

Zamak

L1 (mm) طول کلی	L (mm) آکس سوراخ	W1 (mm) عرض پلاک	W2 (mm) طول دستگیره	Weight (gr) وزن
255	219	48	133	1105

N705



Multi Colour

Zamak

L1 (mm) طول کلی	L (mm) آکس سوراخ	W1 (mm) عرض پلاک	W2 (mm) طول دستگیره	Weight (gr) وزن
255	219	48	134	1185

Door Handle

N706



Multi Colour

Zamak

L1 (mm) طول کلی	L (mm) آکس سوراخ	W1 (mm) عرض پلاک	W2 (mm) طول دستگیره	Weight (gr) وزن
255	219	48	130	1285

N707



Multi Colour

Zamak

L1 (mm) طول کلی	L (mm) آکس سوراخ	W1 (mm) عرض پلاک	W2 (mm) طول دستگیره	Weight (gr) وزن
-	-	-	-	-

N709



Multi Colour

Zamak

L1 (mm) طول کلی	L (mm) آکس سوراخ	W1 (mm) عرض پلاک	W2 (mm) طول دستگیره	Weight (gr) وزن
-	-	-	-	-

Door Handle

N601

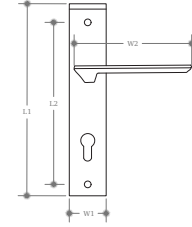

Aluminium-Steel

L1 (mm) طول کلی	L2 (mm) آکس سوراخ	W1 (mm) عرض پلاک	W2 (mm) طول دستگیره	Weight (gr) وزن
247	202	43	132	515

N603

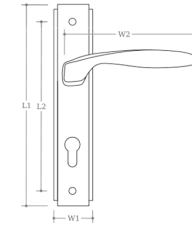

Aluminium-Steel

L1 (mm) طول کلی	L2 (mm) آکس سوراخ	W1 (mm) عرض پلاک	W2 (mm) طول دستگیره	Weight (gr) وزن
260	202	45	122	577

N604



Aluminium-Steel

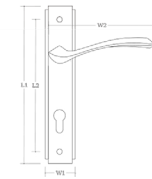

L1 (mm) طول کلی	L2 (mm) آکس سوراخ	W1 (mm) عرض پلاک	W2 (mm) طول دستگیره	Weight (gr) وزن
260	202	45	120	567

Pull Handle

N701



Aluminium

L (mm) طول کلی	size (mm) سایز	H (mm) ارتفاع	L (mm) طول	W (mm) عرض	Weight (gr) وزن
650	457	35	35	35	2410
1100	815	35	35	35	3870

Multi Colour

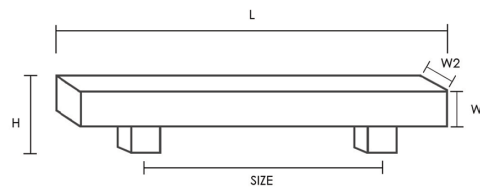



Hooks
Focus on Quality

Hook

NH01



Zamak

H(mm) ارتفاع	W1(mm) عرض بالا	W2 (mm) عرض پایین	Weight (gr) وزن
119	44	62	114

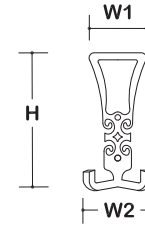

NH02



Zamak

H(mm) ارتفاع	W1(mm) عرض بالا	W2 (mm) عرض پایین	Weight (gr) وزن
121	35	73	104

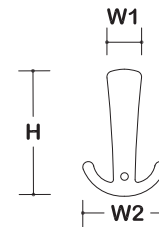

NH03



Aluminium

H(mm) ارتفاع	W1(mm) عرض بالا	W2 (mm) عرض پایین	Weight (gr) وزن
116	33	77	60

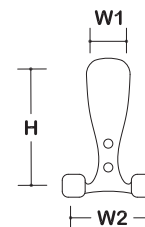

Hook

NH04



Aluminium

H (mm) ارتفاع	W1(mm) عرض بالا	W2 (mm) عرض پایین	Weight (gr) وزن
134	83	83	65

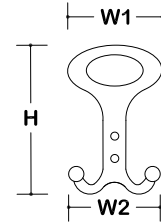

NH05



Aluminium

H (mm) ارتفاع	W1(mm) عرض بالا	W2 (mm) عرض پایین	Weight (gr) وزن
165	42	64	58

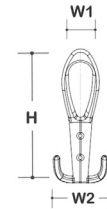

NH06



Zamak

H (mm) ارتفاع	W1(mm) عرض بالا	W2 (mm) عرض پایین	Weight (gr) وزن
-	-	-	-



Cabinet Legs
Focus on Quality

Cabinet Leg

L16



Ronika

Colour

Aluminium-PP

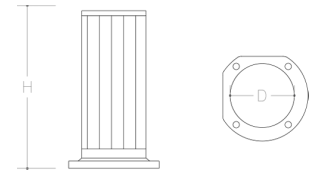

H (mm) سایز	6	8	10	12	14	20	25
D (mm) قطر	50	50	50	50	50	50	50

L16



Ronika

Colour

Aluminium-PP

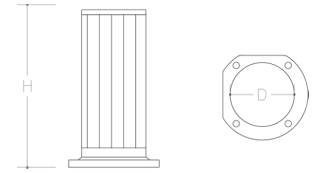

H (mm) سایز	6	8	10	12	14	20	25
D (mm) قطر	50	50	50	50	50	50	50

L16



Ronika

Colour

Aluminium-PP

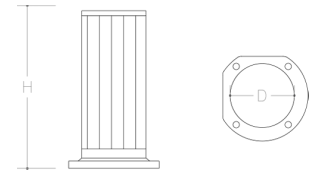

H (mm) سایز	6	8	10	12	14	20	25
D (mm) قطر	50	50	50	50	50	50	50

Cabinet Leg

L50



Dorna



Aluminium-ABS

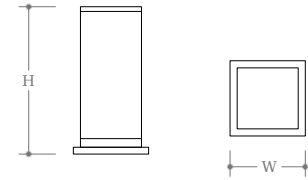

H (mm) سایز	26	8	10	12	14	20	25
W (mm) عرض	40	40	40	40	40	40	40

L53



Dorna



Aluminium-ABS

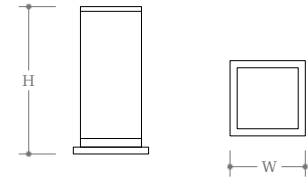

H (mm) سایز	6	8	10	12	14	20	25
W (mm) عرض	40	40	40	40	40	40	40

L54



Dorna



Aluminium-ABS

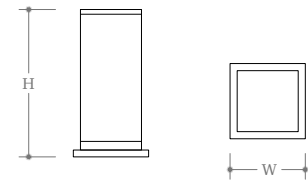

H (mm) سایز	6	8	10	12	14	20	25
W (mm) عرض	40	40	40	40	40	40	40

Cabinet Leg

L11



Romina



Aluminium-PP

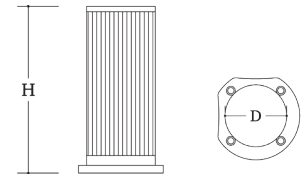

H (mm) سایز	6	8	10	12	14	20	25
D (mm) قطر	50	50	50	50	50	50	50

L12



Romina



Aluminium-PP

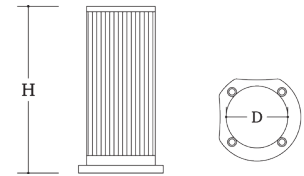

H (mm) سایز	6	8	10	12	14	20	25
D (mm) قطر	50	50	50	50	50	50	50

L14



Romina



Aluminium-PP

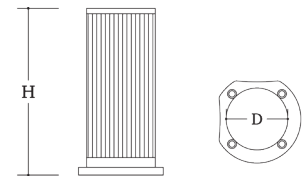

H (mm) سایز	6	8	10	12	14	20	25
D (mm) قطر	50	50	50	50	50	50	50

Cabinet Leg

L10



Romina



Aluminium-PP

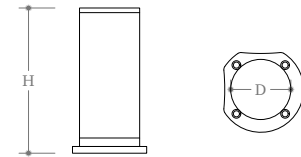

H (mm) سایز	6	8	10	12	14	20	25
D (mm) قطر	50	50	50	50	50	50	50

LS50



Romina



Stainless Steel-PP

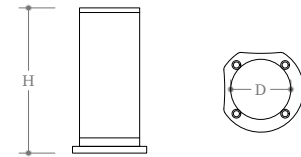

H (mm) سایز	6	8	10	12	14	20	25
D (mm) قطر	50	50	50	50	50	50	50

LS45



Roya



Stainless Steel-PP

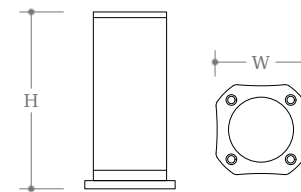

H (mm) سایز	6	8	10	12	14	20	25
D (mm) قطر	45	45	45	45	45	45	45

Cabinet Leg

L20



Roya

Colour

Aluminium-PP

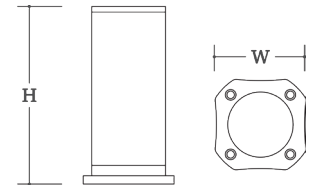

H (mm) سایز	6	8	10	12	14	20	25
D (mm) قطر	45	45	45	45	45	45	45

51

www.nicehw.com

L21



Roya

Colour

Aluminium-PP

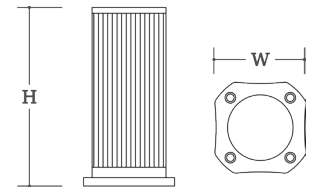

H (mm) سایز	6	8	10	12	14	20	25
D (mm) قطر	45	45	45	45	45	45	45

Cabinet Leg

LP20



Ronak



PP

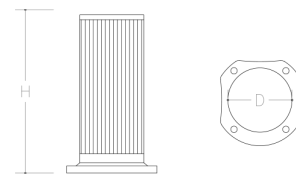

H (mm) سایز	6	8	10	12	14
D (mm) قطر	50	50	50	50	50

BL23



Rasta



PP

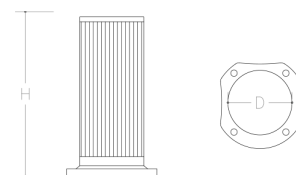

H (mm) سایز	6	8	10	12	14
D (mm) قطر	45	45	45	45	45

Aluminium Profiles

Focus on Quality

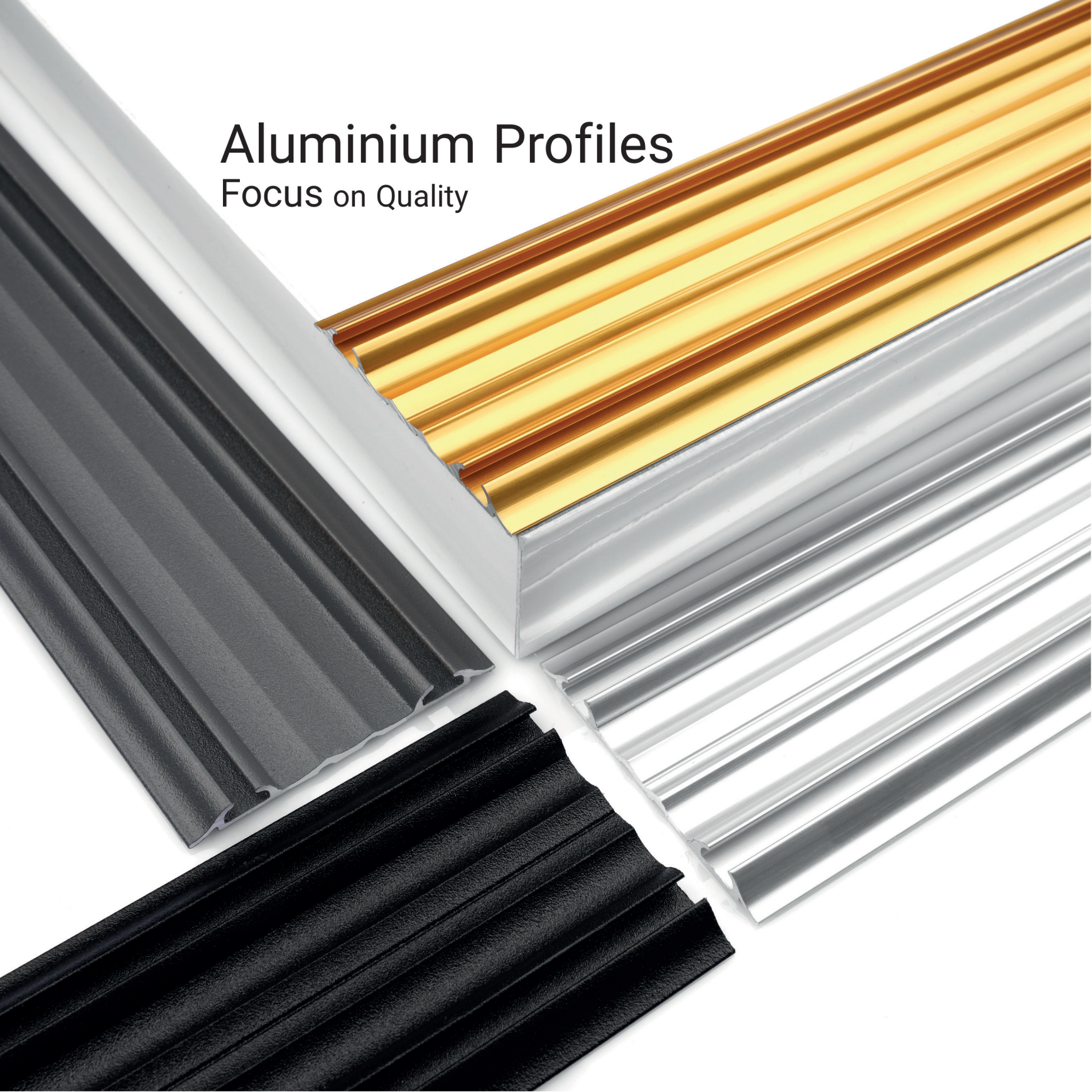

Cabinet handles colour



AD
آنودایز مات

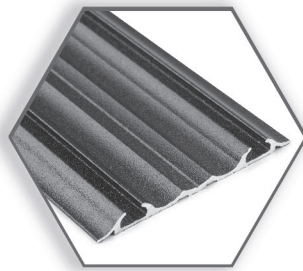

Black
مشکی

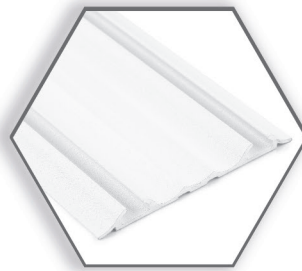

White
سفید

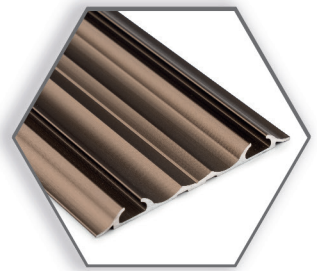

DCM
شامپاینی تیره

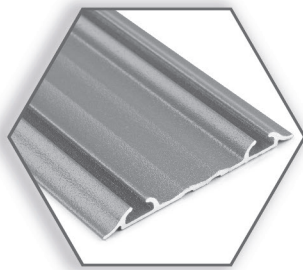

Gray
طوسی سمباده‌ای

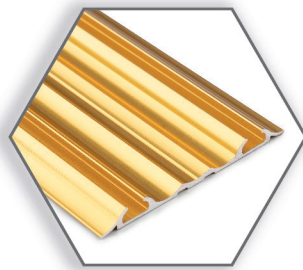

GP
طلایی براق

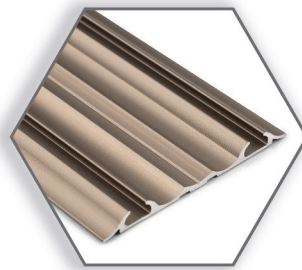

LCM
شامپاینی روشن

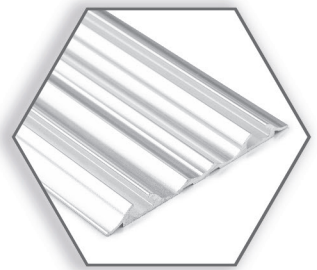

CP
کروم براق

Aluminium Profile

H1



دستگیره شاخه‌ای هلالی ساده



L1 (mm)	L2 (mm)	L3 (mm)	H (mm)
21.6	16.6	15.7	16.3

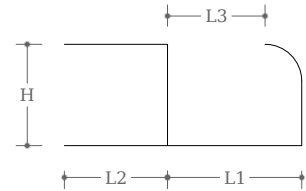

H3



دستگیره شاخه‌ای جی فرم



L (mm)	H (mm)
35	18



H4



دستگیره ال لبه‌دار طرح ترک



L1(mm)	L2(mm)	L3 (mm)	H2 (mm)
16.3	14.2	22	9.5

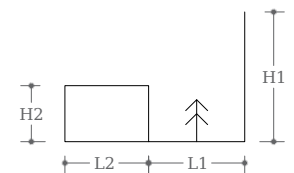

Aluminium Profile

H6



دستگیره شاخه‌ای هلالی نمدخور



L1(mm)	L2(mm)	L3 (mm)	H (mm)
20.6	19	15.7	16.2

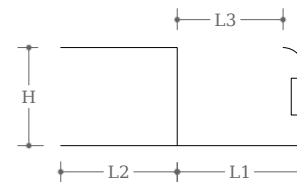

H7

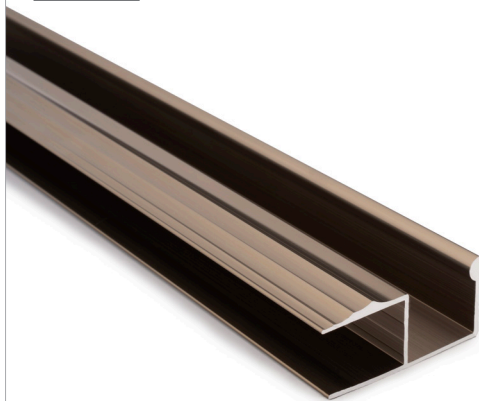

دستگیره شاخه‌ای طرح اتریش



L1 (mm)	L2 (mm)	H (mm)
20.1	19.7	16.2

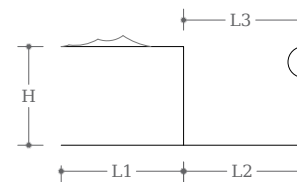

H8

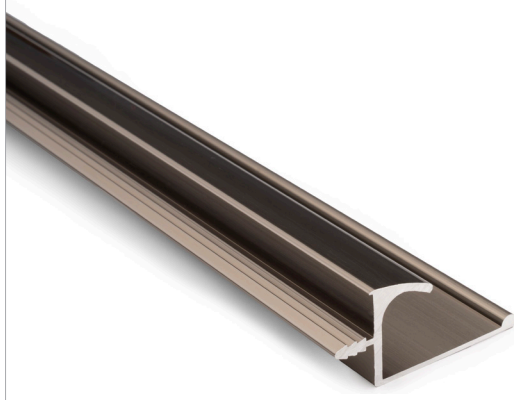

دستگیره شاخه‌ای لام فرم



L1(mm)	L2(mm)	L3 (mm)
18	36	9

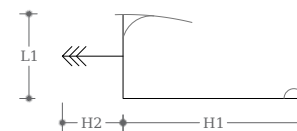

Aluminium Profile

P1



دستگیره یو مخفی کابینتی

Multi Colour



L1(mm)	H(mm)
69	24.6

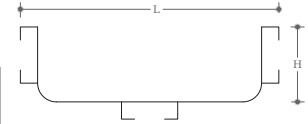

P2

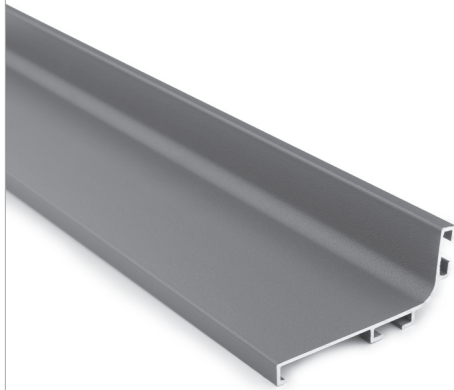

دستگیره ال مخفی کابینتی

Multi Colour



L1(mm)	H(mm)
56	24.6

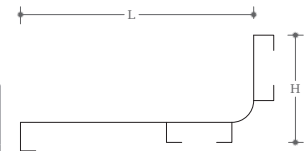

P3



پروفیل یو مقابل

Multi Colour



L1(mm)	H(mm)
20	16.2

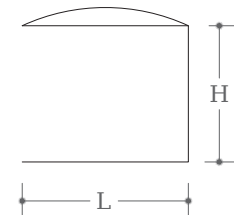

Aluminium Profile

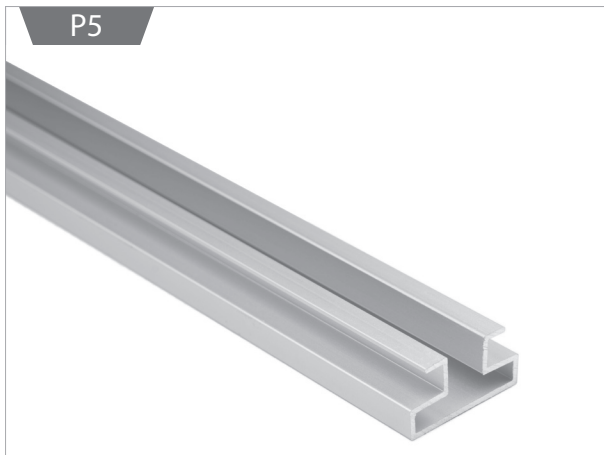

ريل رگال آلومينيومی

Colour

L1(mm)	L2(mm)	L3(mm)	H1(mm)	H2(mm)
25	7.5	3	6	5.5

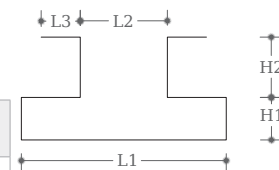

پروفيل اچ بين دو صفحه

Multi Colour

L1 (mm)	L2 (mm)	H (mm)
28	20	16.2

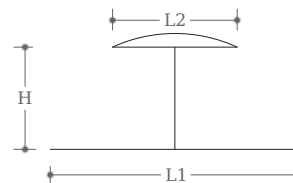

دستگیره ال مخفی کمدی

Multi Colour

L (mm)	H (mm)
46	36

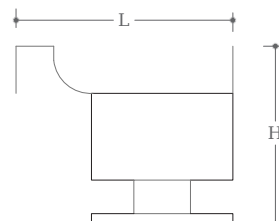

Aluminium Profile

P9

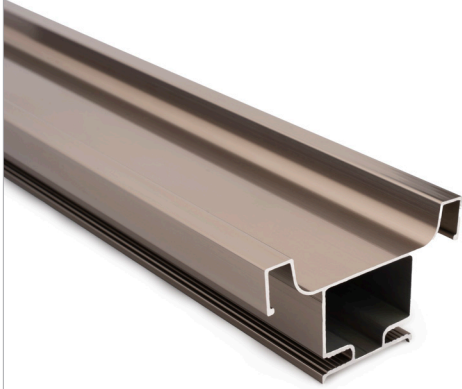

دستگیره یو مخفی کمډی

Multi Colour



L (mm)	H (mm)
46	36

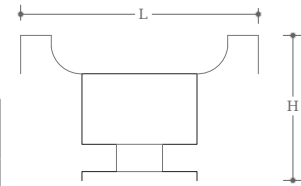

RS1



ریل ۸۰ کیلویی توکار

Colour



L1 (mm)	L2 (mm)
42.7	34.5

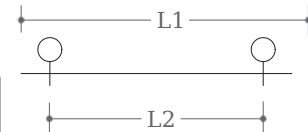

RS2



ریل ناودونی دوکاناله بالایی

Colour



L1(mm)	L2(mm)	H1 (mm)	H2 (mm)
57.6	20.4	17.5	4.8

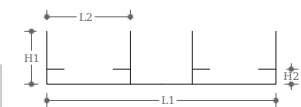

Aluminium Profile

RS3



ریل ۱۰۰ کیلویی خزینه دار

Multi Colour

L (mm)	L2 (mm)
54	33.8

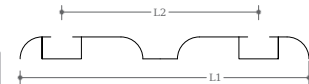

RS4



ریل پیشانی دار خزینه دار

Multi Colour

L1(mm)	L2(mm)	H (mm)
77.7	36.9	24.1

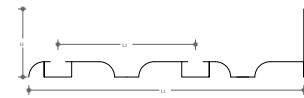

RS5



ریل بالا تاپ لاین

Colour

L1(mm)	L2(mm)	H (mm)
72.6	37.8	13.8

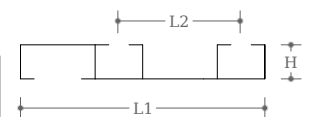

Aluminium Profile

RS6



ريل پايين تاپ لاین

Colour

L (mm)	L2 (mm)
69.2	37.8

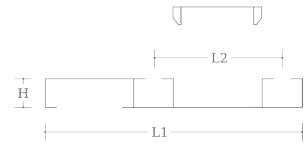

R11

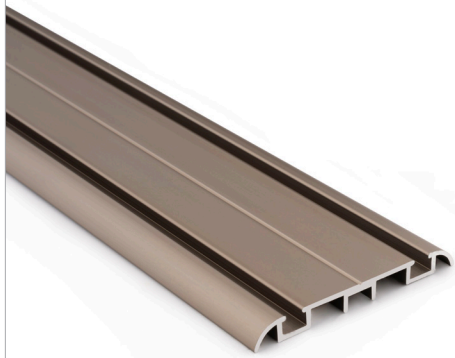

ريل ۷۵ كيلویی خاك نگیر سنگین

Multi Colour

L (mm)	L2 (mm)
54.2	34.2

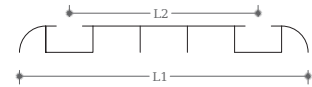

R21



ريل ۷۵ كيلویی معمولی سنگین

Multi Colour

L (mm)	L2 (mm)
52	38.1

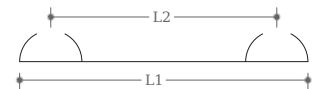

Aluminium Profile



ریل ۹۰ کیلویی معمولی

Multi Colour

L (mm)	L2 (mm)
62.8	40

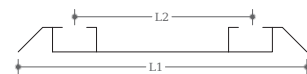

ریل ۹۰ کیلویی کاوردار

Multi Colour

L (mm)	L2 (mm)
62.8	42

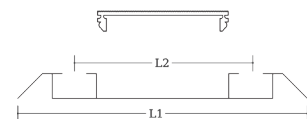

ریل ۹۰ کیلویی طرح ترک

Multi Colour

L (mm)	L2 (mm)
57.7	43

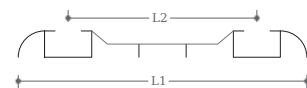

Aluminium Profile

R91



ریل ۹۰ کیلویی طرح اتریش

Multi Colour



L (mm)	L2 (mm)
61	40

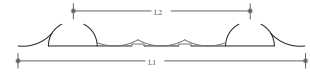

R7



ریل ۷۵ کیلویی خزینه دار

Colour



L (mm)	L2 (mm)
52	31.8

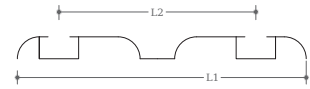

R81



ریل ۹۰ کیلویی یک طرفه

Multi Colour



L (mm)
32

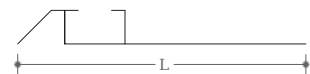

Aluminium Profile



لوله بیضی ساده



L (mm)	D (mm)
29.8	14.5

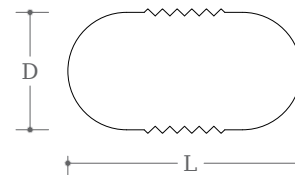

لوله گرد شیاردار



D (mm)
25

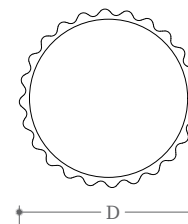

لوله بیضی لاستیک خور



L (mm)	H (mm)
29	14.4

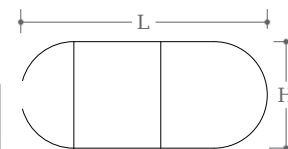

Aluminium Profile

L 4



لوله بیضی LED دار

Multi Colour



L (mm)	D (mm)
24	35

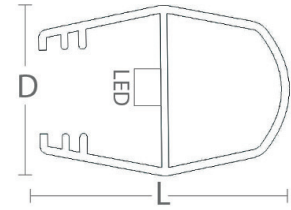

PA14

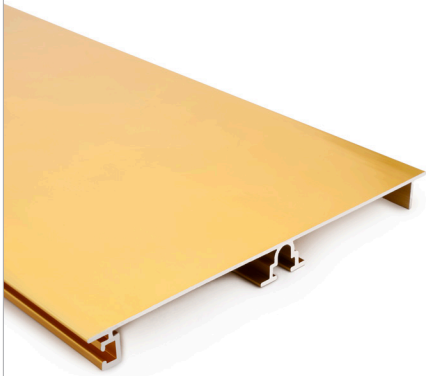

پاخور آلومینیومی ۱۴ سانت

Multi Colour

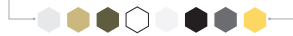

L (CM)
14

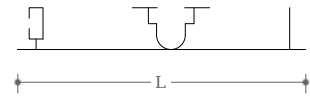

PA10

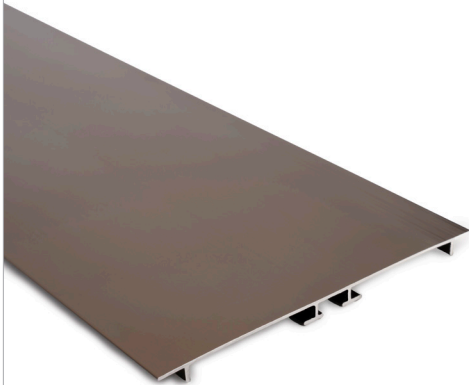

پاخور آلومینیومی ۱۰ سانت

Multi Colour

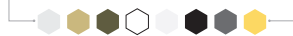

L (CM)
10

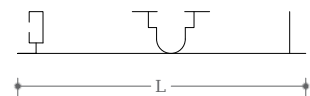

Aluminium Profile



H9

دستگیره ال لبه دار ترک منحنی



L (mm)	H (mm)
30.4	22

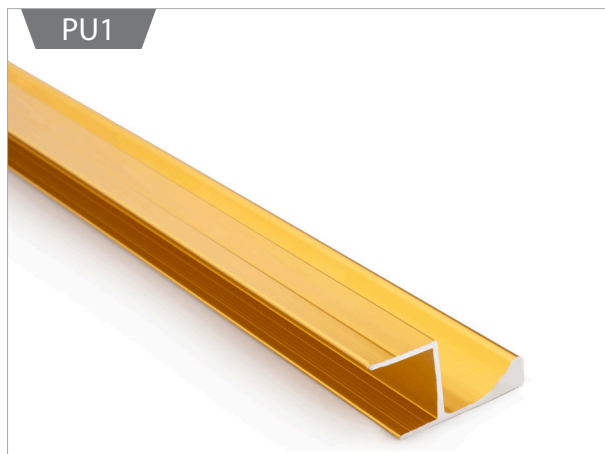
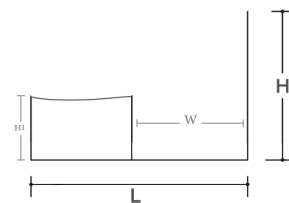

PU1

دستگیره مخفی هوایی



L (mm)	H (mm)
31	16.2

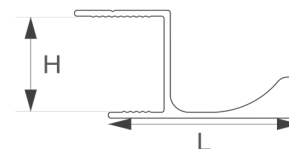

P7

پروفیل اچ بین دو صفحه- تارا



L (mm)	H (mm)
29	16.2

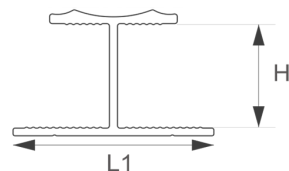

Aluminium Profile

H2



دستگیره شاخه‌ای هلالی
نمدخور-تارا

Multi Colour

L (mm)	H (mm)
48	16.2

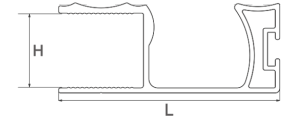

H5

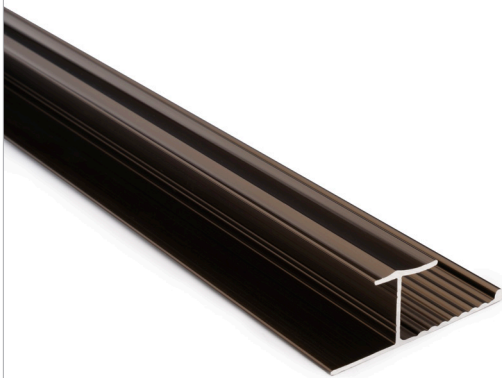

دستگیره شاخه‌ای لام فرم-تارا

Multi Colour

L (mm)	H (mm)
48	16.2

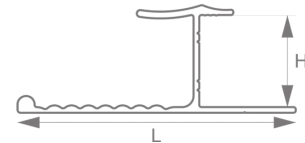

P4

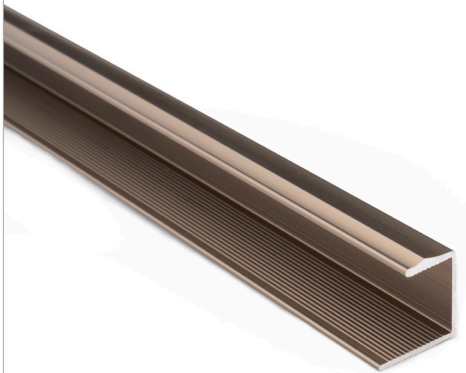

پروفیل یو مقابل-تارا

Multi Colour

L (mm)	H (mm)
18.6	16.2

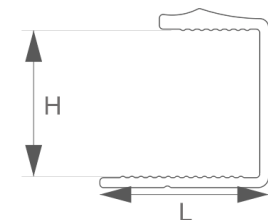

Aluminium Profile

S100/S200



بغل صفحه

Colour

Code	L (mm)	H (mm)
S100	32	6
S200	50	6



S300/S400



سپری

Colour

Code	L (mm)	H (mm)
S300	32	15
S400	50	15

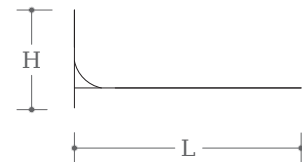

Linear Light

LL01



چراغ LED تو کار لبه دار

پروفیل فوق با نور آفتابی، مهتابی و نچرال در سایزهای دلخواه مشتری تولید می شود.



Aluminium

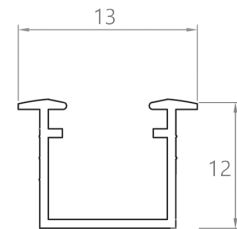

SIZE (mm)	60	90	120	150	180
-----------	----	----	-----	-----	-----

69

www.nicehw.com

LL02

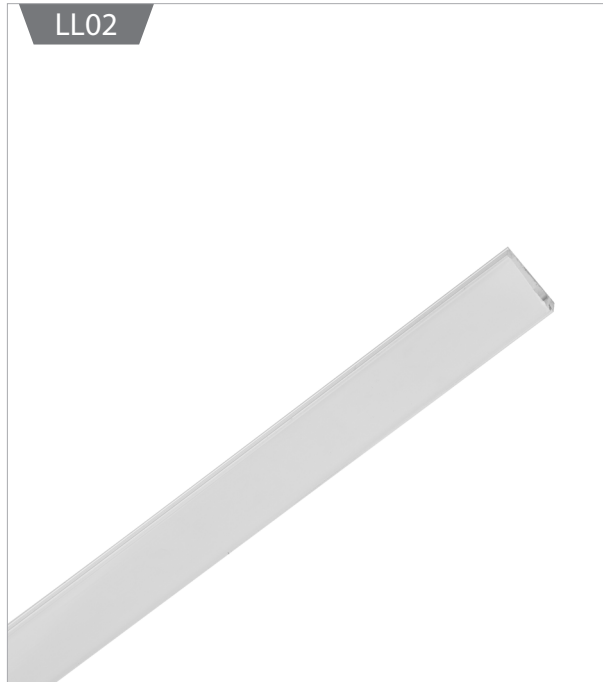

چراغ LED توکار بدون لبه

پروفیل فوق با نور آفتابی، مهتابی و نچرال در سایزهای دلخواه مشتری تولید می شود.



Aluminium

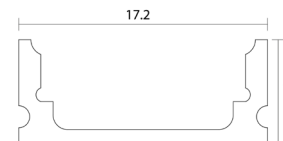

SIZE (mm)	60	90	120	150	180
-----------	----	----	-----	-----	-----

Linear Light

LL03



چراغ LED کنج

پروفیل فوق با نور آفتابی، مهتابی و نچرال در سایزهای دلخواه مشتری تولید می‌شود.



Aluminium

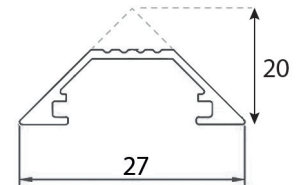

SIZE (cm)	60cm	90cm	120cm	150cm
-----------	------	------	-------	-------

LL04

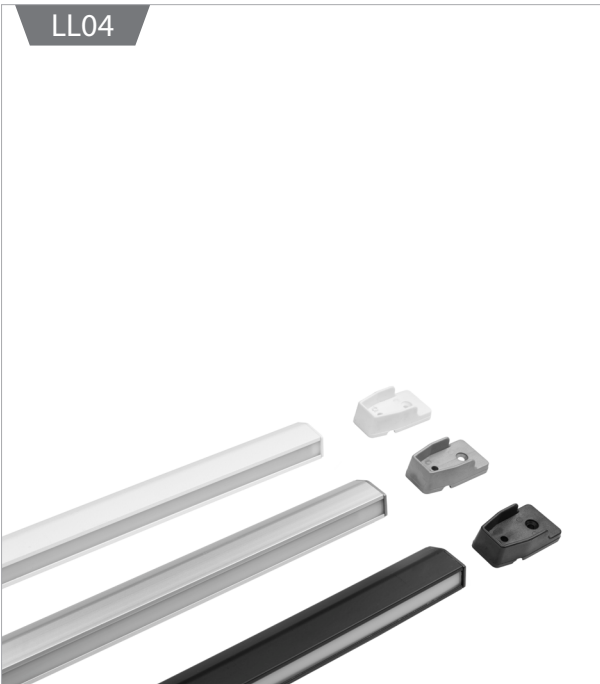

چراغ LED رگال

پروفیل فوق با نور آفتابی، مهتابی و نچرال در سایزهای دلخواه مشتری تولید می‌شود.

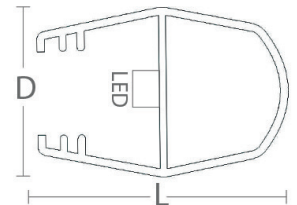

L (mm)	D (mm)
24	35



Glass Door frame

Focus on Quality

Frame Glass Profile

GF01/GF02

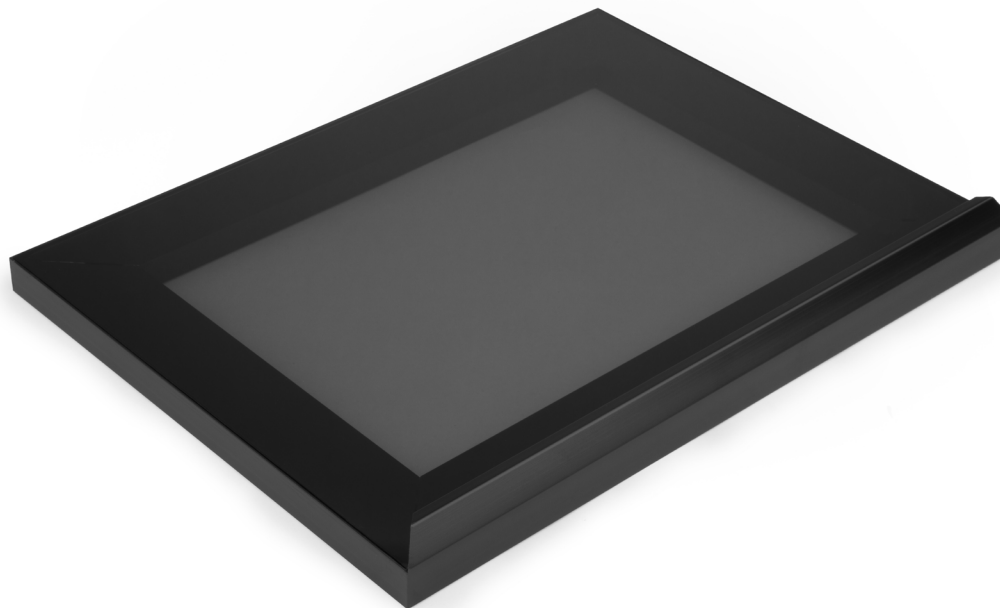

72

www.nicehw.com

پروفیل قاب شیشه‌ای آرینا (فریم لس)

قابلیت نصب شیشه ۴-۵-۶ میلی‌متر

Aluminium

GF01

L (mm)	H1 (mm)	H2 (mm)
45	16	35

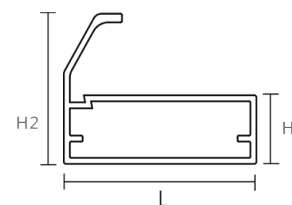

Aluminium

GF02

L (mm)	H1 (mm)	H2 (mm)
45	16	20

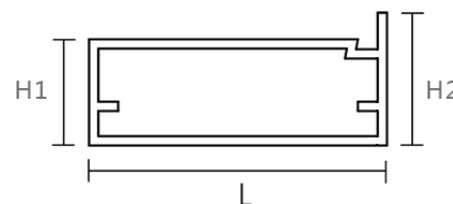

Frame Glass Profile

GF10/GF11

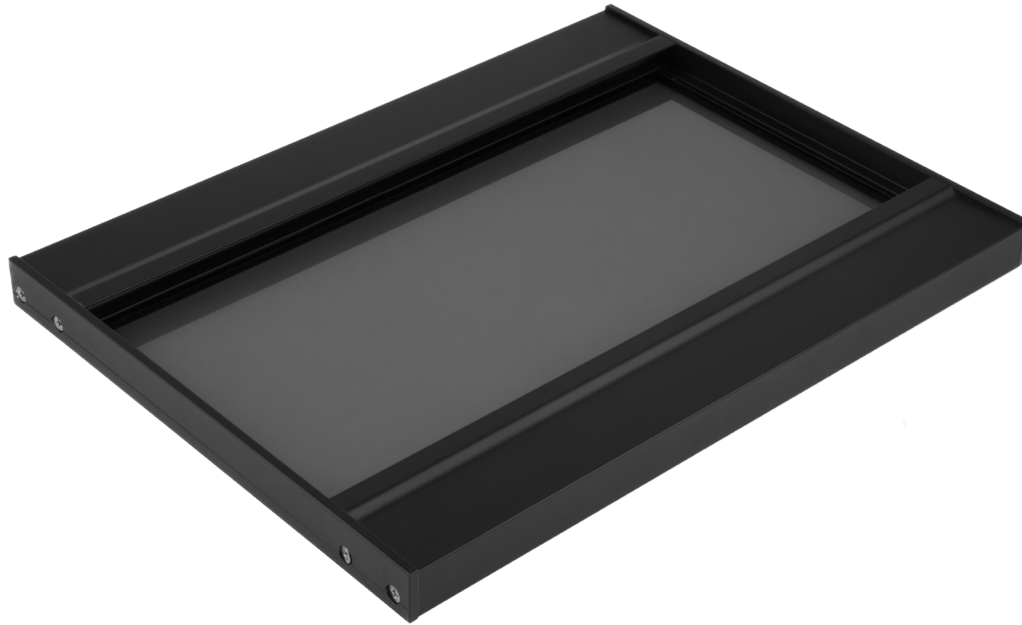

73

www.nicehw.com

پروفیل قاب شیشه‌ای آگرین

قابلیت نصب شیشه ۴ میلی‌متر

Aluminium

GF10

L (mm)	H1 (mm)	H2 (mm)
53	24	27

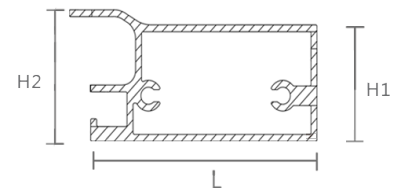

Aluminium

GF11

Size	L (mm)	H1 (mm)
400	45	12
450	45	12
500	45	12
600	45	12

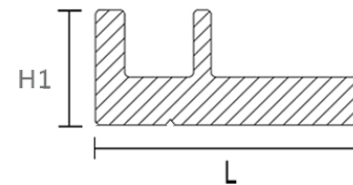

Frame Glass Profile

GF03/GF04

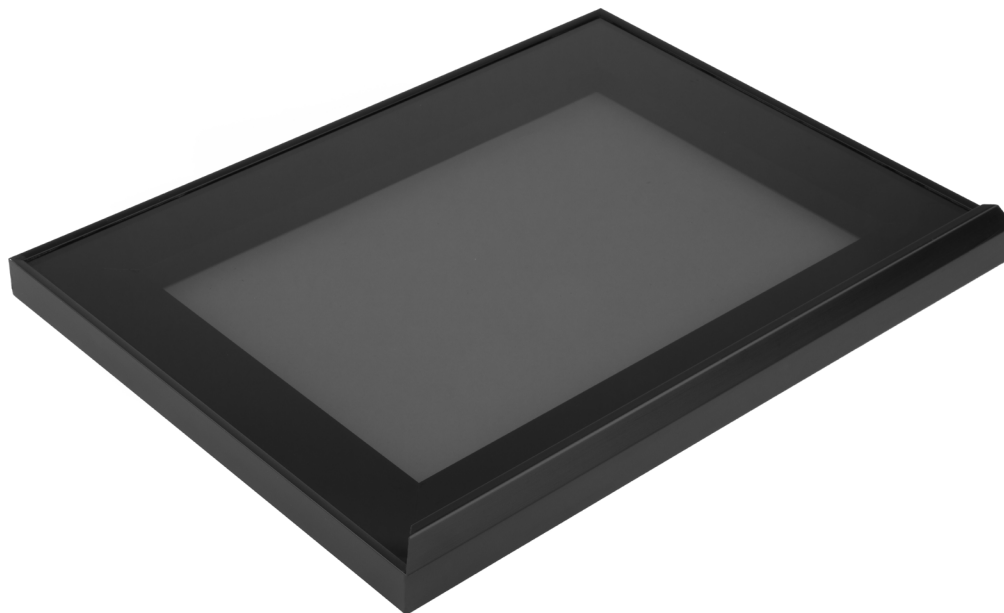

74

www.nicehw.com

پروفیل قاب شیشه‌ای آوینار (فریم‌دار)

قابلیت نصب شیشه ۴ میلی‌متر

Aluminium

GF03

L (mm)	H1 (mm)	H2 (mm)
45	16	33

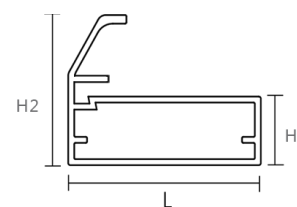

Aluminium

GF04

L (mm)	H1 (mm)	H2 (mm)
45	16	22

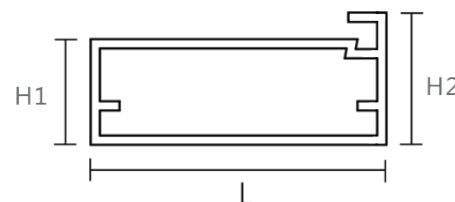



Sliding door systems

Focus on Quality

Sliding Door System

ST50

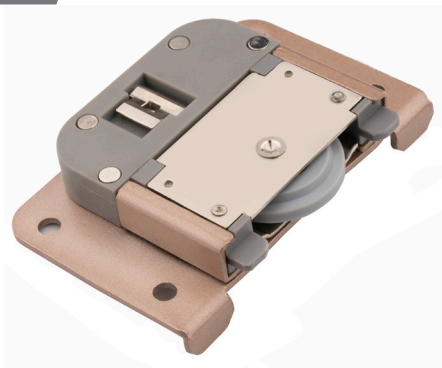

مکانیسم تاپ لاین

Door Weight Max	50 Kg
Door Thickness	16-18 mm
Height Adjustment	Yes
Material	Steel-Pom-Zamak

ST100

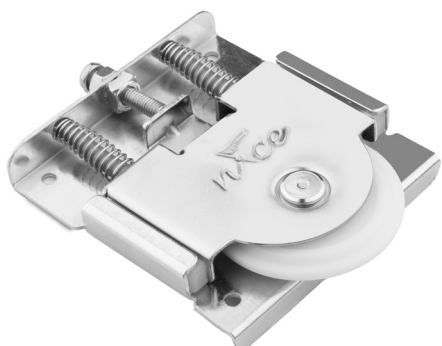

یراق ۱۰۰ کیلویی

Door Weight Max	100 Kg
Door Thickness	16-18 mm
Height Adjustment	Yes
Material	Steel-Pom

ST95

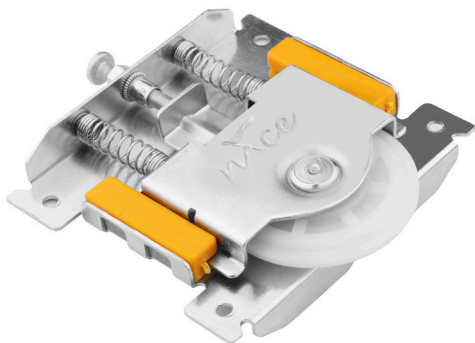

یراق ۹۵ کیلویی

Door Weight Max	95 Kg
Door Thickness	16-18 mm
Height Adjustment	Yes
Material	Steel-Pom

Sliding Door System

ST90

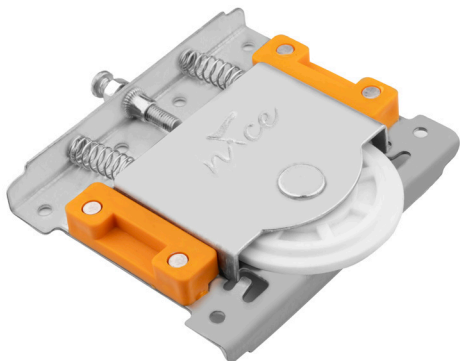

یراق ۹۰ کیلویی

Door Weight Max	50 Kg
Door Thickness	16-32 mm
Height Adjustment	Yes
Material	Steel-Pom

ST90-C

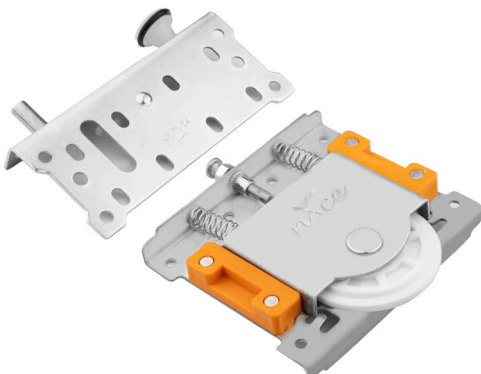

یراق ۹۰ کیلویی ترکیبی

Door Weight Max	90 Kg
Door Thickness	16-32 mm
Height Adjustment	Yes
Material	Steel-Pom

ST90-IN



یراق ۹۰ کیلویی توکار

Door Weight Max	90 Kg
Door Thickness	16-32 mm
Height Adjustment	Yes
Material	Steel-Pom

Sliding Door System

ST80

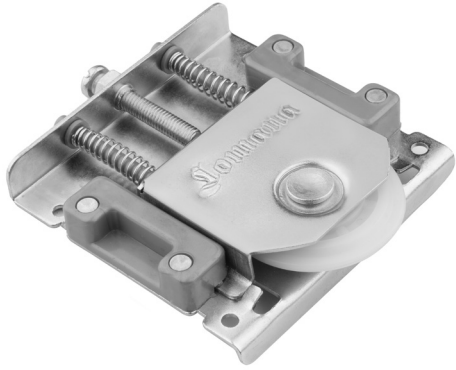

یراق ۸۰ کیلویی لومانا

Door Weight Max	80 Kg
Door Thickness	16-32 mm
Height Adjustment	Yes
Material	Steel-PP

ST70

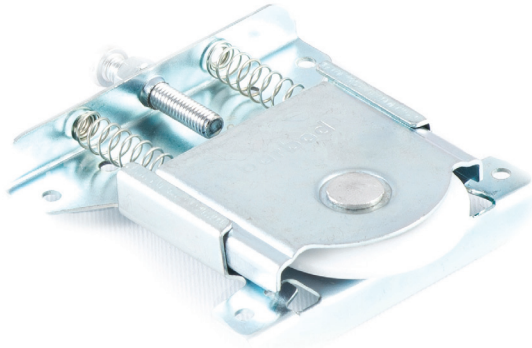

یراق ۷۰ کیلویی باربد

Door Weight Max	70 Kg
Door Thickness	16-32 mm
Height Adjustment	Yes
Material	Steel-PP

ST40



یراق ۴۰ کیلویی (بالایی) لومانا

Door Weight Max	40 Kg
Door Thickness	16-32 mm
Height Adjustment	No
Material	Steel-PP



Hinges
Focus on Quality

Hinge

N240



لولا آرام بند ۶ جهته مشکی

قابلیت نصب تا ضخامت ۲۵ میلی‌متر

Material: Steel with nickel plated

Full overlay

Soft close

Iran clip on

Opening Angle: 98°

Depth of hinge cup: 11.5mm

Diameter of Hinge Cup: 35mm

Door thickness: 14-25mm

Width adjustment: 4mm

Depth adjustment: 4mm

Replaceable butterfly

N240



لولا آرام بند ۶ جهته نیکل

قابلیت نصب تا ضخامت ۲۵ میلی‌متر

Material: Steel with nickel plated

Full overlay

Soft close

Iran clip on

Opening Angle: 98°

Depth of hinge cup: 11.5mm

Diameter of Hinge Cup: 35mm

Door thickness: 14-25mm

Width adjustment: 4mm

Depth adjustment: 4mm

Replaceable butterfly

Hinge

N210 / N210 IN

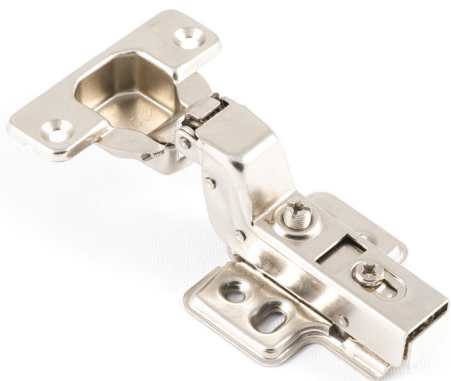

لولا آرام بند روکار-توکار

Material: Steel with nickel plated
Full overlay
Soft close
Zinc clip on
Opening Angle: 98°
Depth of hinge cup: 11.5mm
Diameter of Hinge Cup: 35mm
Door thickness: 14-19mm
Width adjustment: 4mm
Depth adjustment: 4mm
Replaceable butterfly

81

N218 SS / N219 SS



لولا آرام بند استیل کلیپسی و بدون کلیپس

Material: Stainless steel
Full overlay
Soft close
Stainless clip on, Slide on
Opening Angle: 98°
Depth of hinge cup: 11.5mm
Diameter of Hinge Cup: 35mm
Door thickness: 14-18mm
Width adjustment: 4mm
Depth adjustment: 4mm
Replaceable butterfly

Hinge

N213



لولا آرام بند بدون کلیپس سنگین

Material: Steel with nickel plated

Finish: Nickel

Soft close

Slide on

Opening Angle: 110°

Depth of hinge cup: 11.5mm

Diameter of Hinge Cup: 35mm

Door thickness: 14-19mm

Width adjustment: 4mm

Depth adjustment: 4mm

Replaceable butterfly

N212



لولا آرام بند بدون کلیپس سنگین

Material: Steel with nickel plated

Full overlay, Inset

Soft close

Slide on

Opening Angle: 110°

Depth of hinge cup: 11.5mm

Diameter of Hinge Cup: 35mm

Door thickness: 14-19mm

Width adjustment: 4mm

Depth adjustment: 4mm

Replaceable butterfly

Hinge

N220 / N220 IN

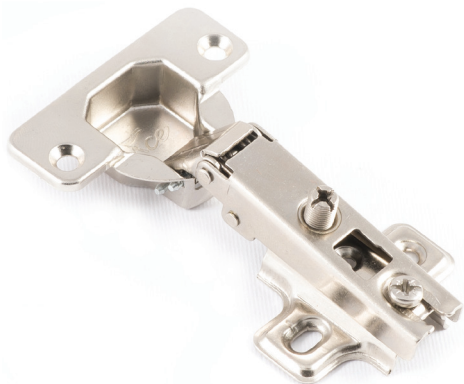

لولاگازور معمولی دو پیچ روکار و توکار

Material: Steel with nickel plated
Full overlay, Inset
Normal
.....
Opening Angle: 110°
Depth of hinge cup: 11.3 mm
Diameter of Hinge Cup: 35mm
Door thickness: 14-19mm
Width adjustment: 7mm
Depth adjustment: 11mm
Replaceable butterfly

N224 / N224 IN

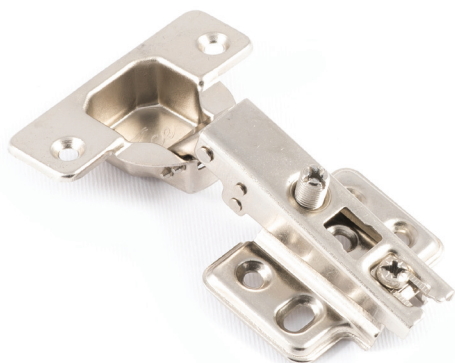

لولاگازور معمولی چهار پیچ روکار و توکار

Material: Steel with nickel plated
Full overlay, Inset
Normal
.....
Opening Angle: 110°
Depth of hinge cup: 11.3mm
Diameter of Hinge Cup: 35mm
Door thickness: 14-19mm
Width adjustment: 7mm
Depth adjustment: 11mm
Replaceable butterfly

Hinge

N231 / N231 C

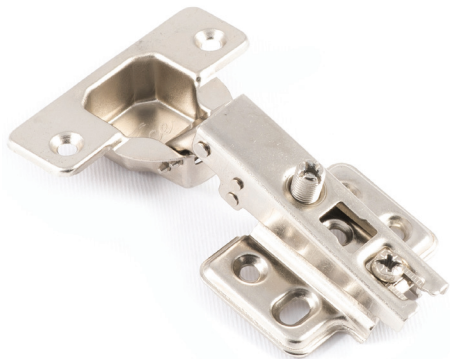

لولا گازور خلاص بدون کلیپسی

Material: Steel with nickel plated

Full overlay

Normal, No spring

Slide on, clip on

Opening Angle: 105-110°

Depth of hinge cup: 11.5mm

Diameter of Hinge Cup: 35mm

Door thickness: 14-18mm

Width adjustment: 4mm

Depth adjustment: 4mm

Replaceable butterfly

N232



لولا گازور ۱۳۵ درجه

Material: Steel with nickel plated

Full overlay

Normal

Slide on

Opening Angle: 135°

Depth of hinge cup: 11.5mm

Diameter of Hinge Cup: 35mm

Door thickness: 14-18mm

Width adjustment: 4mm

Depth adjustment: 4mm

Replaceable butterfly

Hinge

Push Hinge

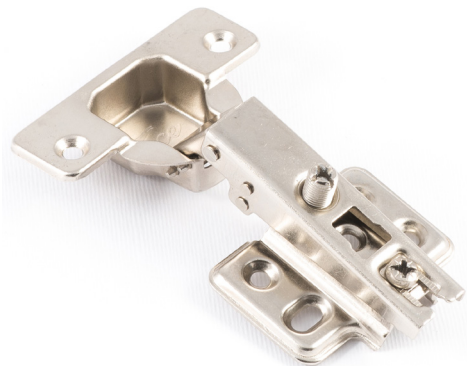

لولا تاج

Material: Steel with nickel plated
Full overlay
Normal, Inverse Spring
Slide on
Opening Angle: 105°
Depth of hinge cup: 11.3mm
Diameter of Hinge Cup: 35mm
Door thickness: 14-18mm
Width adjustment: 3-6mm
Depth adjustment: 3-6mm
Replaceable butterfly

85

N236 / N236 S



لولا گازور ۹۰ درجه معمولی و آرامبند

Material: Steel with nickel plated
Full overlay
Normal, Soft close
Slide on
Opening Angle: 90°
Depth of hinge cup: 11.5mm
Diameter of Hinge Cup: 35mm
Door thickness: 14-18mm
Width adjustment: 4mm
Depth adjustment: 4mm
Replaceable butterfly

Hinge

N235 / N235 S

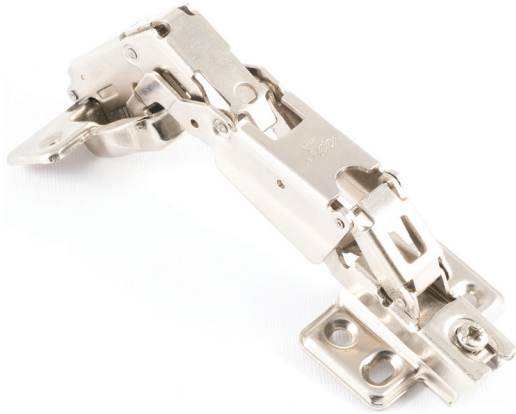

لولا گازور ۱۶۵ درجه معمولی و آرام بند

Material: Steel with nickel plated

Full overlay

Normal, Soft close

clip on

Opening Angle: 165°

Depth of hinge cup: 11.5mm

Diameter of Hinge Cup: 35mm

Door thickness: 14-18mm

Width adjustment: 4mm

Depth adjustment: 4mm

Replaceable butterfly

N240



لولا پروفیلی

Gold - Black - Nickel

Material: Steel with nickel plated

Full overlay

Soft close

clip on

Opening Angle: 98°

Door thickness: 18-22mm

Width adjustment: 2mm

Depth adjustment: 2mm

Replaceable butterfly



Drawer slide

Focus on Quality

Drawer Slid

4515



ریل ساچمه ای عرض ۴۵ سنگین مشکی

size (mm)	Width (mm)	Thickness (mm)
40	45	1.2 / 1.2 / 1.5
45	45	1.2 / 1.2 / 1.5
50	45	1.2 / 1.2 / 1.5
55	45	1.2 / 1.2 / 1.5
60	45	1.2 / 1.2 / 1.5
70	45	1.2 / 1.2 / 1.5

4515



ریل ساچمه ای عرض ۴۵ سنگین آبکاری

size (mm)	Width (mm)	Thickness (mm)
40	45	1.2 / 1.2 / 1.5
45	45	1.2 / 1.2 / 1.5
50	45	1.2 / 1.2 / 1.5
55	45	1.2 / 1.2 / 1.5
60	45	1.2 / 1.2 / 1.5
70	45	1.2 / 1.2 / 1.5

Drawer Slid

4510



ریل ساچمه‌ای عرض ۴۵ آبکاری

size (mm)	Width (mm)	Thickness (mm)
25	45	1 / 1 / 1.2
30	45	1 / 1 / 1.2
35	45	1 / 1 / 1.2
40	45	1 / 1 / 1.2
45	45	1 / 1 / 1.2
50	45	1 / 1 / 1.2
55	45	1 / 1 / 1.2
60	45	1 / 1 / 1.2
70	45	1 / 1 / 1.2

89

4210



ریل ساچمه‌ای عرض ۴۲ آبکاری

size (mm)	Width (mm)	Thickness (mm)
25	42	1 / 1 / 1
30	42	1 / 1 / 1
35	42	1 / 1 / 1
40	42	1 / 1 / 1
45	42	1 / 1 / 1
50	42	1 / 1 / 1

Drawer Slid

4515



ریل ساچمه‌ای عرض ۴۵ آرام بند (مشکی/آبکاری)

size (mm)	Width (mm)	Thickness (mm)
35	45	1.2 / 1.2 / 1.5
40	45	1.2 / 1.2 / 1.5
45	45	1.2 / 1.2 / 1.5
50	45	1.2 / 1.2 / 1.5

4515



ریل ساچمه‌ای عرض ۴۵ تاچ (مشکی/آبکاری)

size (mm)	Width (mm)	Thickness (mm)
35	45	1.2 / 1.2 / 1.5
40	45	1.2 / 1.2 / 1.5
45	45	1.2 / 1.2 / 1.5
50	45	1.2 / 1.2 / 1.5

Drawer Slid

N80



ریل تاندم باکس گالری بلند

size (cm)	Height (cm)	Weight Bearing (Kg)
40	13	Up to 50 Kg
45	13	Up to 50 Kg
50	13	Up to 50 Kg

91

www.nicehw.com

N80 Double



ریل تاندم باکس گالری بلند دوميله

size (cm)	Height (cm)	Weight Bearing (Kg)
40	19.5	Up to 50 Kg
45	19.5	Up to 50 Kg
50	19.5	Up to 50 Kg

Drawer Slid

N81



ریل تاندم باکس گالری کوتاه

size (cm)	Height (cm)	Weight Bearing (Kg)
40	7.5	Up to 50 Kg
45	7.5	Up to 50 Kg
50	7.5	Up to 50 Kg

N82



ریل تاندم باکس آرام بند اسلیم

size (cm)	Height (cm)	Weight Bearing (Kg)
40	-	Up to 50 Kg
45	-	Up to 50 Kg
50	-	Up to 50 Kg

Drawer Slid

N83

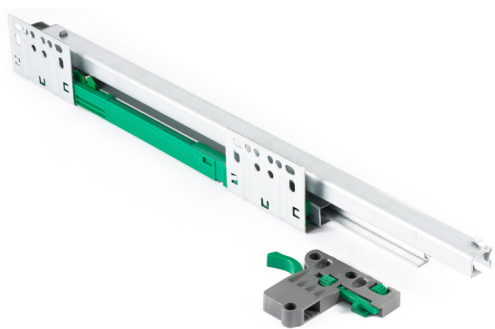

ریل تاندم تاچ فول

size (cm)	FOLD	Weight Bearing (Kg)
30	3	Up to 50 Kg
35	3	Up to 50 Kg
40	3	Up to 50 Kg
45	3	Up to 50 Kg
50	3	Up to 50 Kg

93

www.nicehw.com

N84



ریل تاندم آرام بند فول

size (cm)	FOLD	Weight Bearing (Kg)
30	3	Up to 50 Kg
35	3	Up to 50 Kg
40	3	Up to 50 Kg
45	3	Up to 50 Kg
50	3	Up to 50 Kg

Drawer Slid

N85

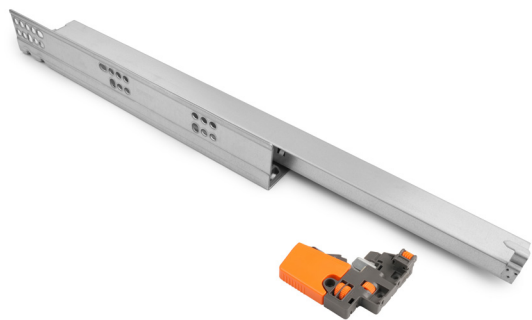

ریل تاندم آرام بند فول 3D

size (mm)	Width (mm)	Thickness (mm)	Weight Bearing (Kg)
25	3	1.8 / 1.5 / 1.2	Up to 30 Kg
30	3	1.8 / 1.5 / 1.2	Up to 30 Kg
35	3	1.8 / 1.5 / 1.2	Up to 30 Kg
40	3	1.8 / 1.5 / 1.2	Up to 30 Kg
45	3	1.8 / 1.5 / 1.2	Up to 30 Kg
50	3	1.8 / 1.5 / 1.2	Up to 30 Kg
55	3	1.8 / 1.5 / 1.2	Up to 30 Kg

N86

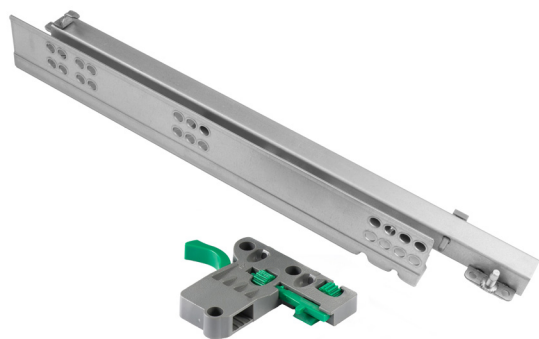

ریل تاندم آرام بند نیمه فول

size (mm)	Width (mm)	Thickness (mm)	Weight Bearing (Kg)
30	2	1.5 / 1.5	Up to 20 Kg
35	2	1.5 / 1.5	Up to 20 Kg
40	2	1.5 / 1.5	Up to 20 Kg
45	2	1.5 / 1.5	Up to 20 Kg
50	2	1.5 / 1.5	Up to 20 Kg



Magnetic Latch

Focus on Quality

Magnetic Latch

N451



مگنت قفل دار کودک

Material	POM
Plastic Colour	White
Size	D: 7.03mm / L:115mm

N450



مگنت قفل دار کودک صلیبی

Material	POM
Plastic Colour	White
Size	D: 7.03mm / L:115mm

N452



مگنت آلومینیومی صلیبی

Material	AL
Plastic Colour	Silver/ Gold/ Titanium
Size	D: 12mm / L:107mm

Magnetic Latch

N42



مگنت صلیبی تنظیم‌دار

Material	Plastic
Plastic Colour	Grey
Size	D: 10 mm / L:75 mm

N47



مگنت صلیبی

Material	Plastic
Plastic Colour	White
Size	D: 15 mm / L:75 mm

N49



مگنت صلیبی لبه‌دار

Material	Plastic
Plastic Colour	White
Size	D: 15 mm / L:110 mm

Magnetic Latch

N446



مگنت تک قلو آلومینیومی

Material	Plastic / AL
Plastic Colour	Grey - GOLD
Size	D: 20 mm / L:140 mm

N445



مگنت دو قلو آلومینیومی

Material	Plastic / AL
Plastic Colour	Grey - GOLD
Size	D: 20 mm / L:140 mm

N41S



مگنت استیل

Material	Plastic / Steel
Plastic Colour	White
Size	D: 20 mm / L:120 mm

Magnetic Latch

N48



مگنت موشکی

Material	Plastic
Plastic Colour	Grey
Size	D: 10 mm / L:110 mm

N40



مگنت مدادی

Material	Plastic
Plastic Colour	White
Size	D: 10 mm / L:110 mm

N43



مگنت پاور

Material	Plastic
Plastic Colour	White
Size	D: 15 mm / L:75 mm



Gas spring
Focus on Quality

Cabinet Support Fitting

N350



جک پمپی آرام بند (طرح آلمان)

Type	Soft Close Gas Spring
Power	N80 / 100N/ 120N/ 150N
Colour	Dark Gray
Ring	Brass

N31-S



جک پمپی آرام بند

Type	Soft Close Gas Spring
Power	N80 / 100N/ 120N/ 150N
Colour	White/ Silver
Ring	Brass

N31



جک پمپی

Type	Normal Gas Spring Support
Power	60N/ 80N/ 100N/ 120N/ 150N
Colour	White/ Silver
Ring	Brass

Cabinet Support Fitting

N32



جک پمپی معکوس

Type	Down Gas Spring Support
Power	100N
Colour	White/ Silver
Ring	Brass

N33



جک پمپی کاوردار

Type	Gas Spring Support With Cover
Power	100N/ 120N
Colour	Gold/ White
Ring	Brass

N35 / N35S

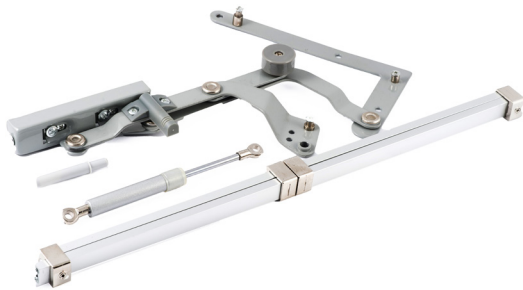

جک اتوبوسی معمولی و آرام بند

Type	Lift up flap stay cabinet supports/ Soft Close
Loading	8 Kg
Length of the bar	60-90 Cm
Ring	Chrome
Accessories	Standard

Cabinet Support Fitting

N37 / N37 Power



جک لمپ سبک و سنگین

Type	Hydraulic Flap Stay Cabinet Support
Finish	Silver
Capacity	2- 4 Kg
Capacity Power	3- 5 Kg

N34



جک بازویی

Type	Hydraulic Support/ Soft down stay R/L
Power
Finish	Chrome
Accessories	Standard

N36



جک ساعتی

Type	Lift up stay support
Finish	Nickle
Max Opening Angle	110 Degree
Adevantage	Power of opening or closing is adjustable

Cabinet Support Fitting

N38



جک HK

Type	Soft close Flap Stay Cabinet Supports
Max Capacity	8 Kg
Available	Up turning doors
Finish	Nickle
Max Opening Angle	110 Degree
Adevantage	Power of opening or closing is adjustable

N368

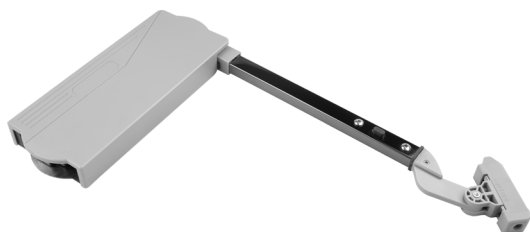

جک اونتوس سنگین

Type	Hydraulic Flap Stay Cabinet Support
Finish	Plating
Capacity	8.07 -17 Kg
Capacity Power	Adjustable

N367

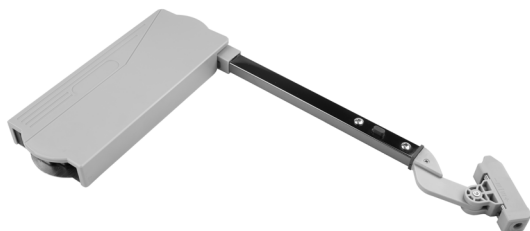

جک اونتوس متوسط

Type	Hydraulic Flap Stay Cabinet Support
Finish	Plating
Capacity	6.25 -12.14 Kg
Capacity Power	Adjustable



Locks
Focus on Quality

Cylinder



سیلندر برنجی ضدبرش



Code	Size	Body	Core	Key
N982	70 (30-40)	Brass (drill-anti)	Brass	5 Brass
N997	70 (35-35)	Brass (drill-anti)	Brass	5 Brass



سیلندر برنجی



Code	Size	Body	Core	Key
N981	70 (30-40)	Brass	Brass	5 Brass
N983	70 (35-35)	Brass	Brass	5 Brass
N986	80 (35-45)	Brass	Brass	5 Brass
N993	80 (40-40)	Brass	Brass	5 Brass
N987	90 (40-50)	Brass	Brass	5 Brass
N996	90 (45-45)	Brass	Brass	5 Brass



سیلندر زاماک



Code	Size	Body	Core	Key
N995	60 (30-30)	Zinc	Brass	5 Iron
N985	70 (30-40)	Zinc	Brass	5 Iron
N994	70 (35-35)	Zinc	Brass	5 Iron
N984	80 (35-45)	Zinc	Brass	5 Iron
N998	80 (40-40)	Zinc	Brass	5 Iron

Cylinder



سیلندر زاماک سرویس



Code	Size	Body	Core	Key
N988	70 (35-35)	Zinc	Zinc	No Key
N989	80 (40-40)	Zinc	Zinc	No Key



سیلندر برنجی آپارتمانی



Code	Size	Body	Core	Key
N990	70 (30-40)	Brass	Brass	5 Brass
N991	70 (35-35)	Brass	Brass	5 Brass
N992	80 (35-45)	Brass	Brass	5 Brass
N993	80 (40-40)	Brass	Brass	5 Brass

Drawer Lock

N911



قفل طرح رونیز تک پله

Material	Zinc
Surface finish	Nickle
Usage	Cabinet door
Type	One Step
Key type	With folding key
Diameter	D: 19mm / L: 22mm

N921



قفل گرد فشاری

Material	Zinc
Surface finish	Nickle
Usage	Cabinet door
Key type	With folding key
Diameter	D: 19mm / L: 20mm

N912



قفل طرح رونیز دو پله گلو بلند-گلو کوتاه

Material	Zinc
Surface finish	Nickle
Usage	Cabinet door
Type	Two Step
Key type	With folding key
Diameter	D: 19mm / L: 22mm / 32mm

Drawer Lock

N950



قفل دو پله کمدی

Material	Zinc / Steel
Surface finish	Nickle
Usage	Wardrobe
Key type	Normal key
Diameter	D: 20mm / L: 28mm

109

www.nicehw.com

N93-3 / N93-4

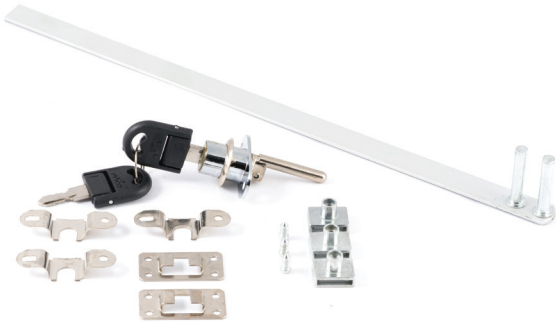

قفل فایل سه کشو - چهار کشو

Material	Zinc / Steel
Colour	Nickle
Key type	Wardrobe
Size N93-3	600 mm
Size N93-4	1200 mm
Diameter	D: 17mm / L: 20mm
Diameter	D: 17mm / L: 20mm

Door Lock

NL914



قفل پهن درب

Material	Brass / Iron
Colour	Cp - Mab - Gp - Black - Gray
Type	Switch
size (mm)	60 - 90

NL912



قفل پهن درب

Material	Brass / Iron
Colour	Cp - Mab - Gp - Black - Gray
Type	Switch
size (mm)	50 - 80

Door Lock



قفل پهن درب

Code	Material	Colour	Type	size (mm)
NL905	Brass / Iron	Cp - Mab - Gp - Black - Gray	Key	45 - 70
NL906	Brass / Iron	Cp - Mab - Gp - Black - Gray	W.c	45 - 70
NL907	Brass / Iron	Cp - Mab - Gp - Black - Gray	Switch	45 - 70



قفل پهن درب

Code	Material	Colour	Type	size (mm)
NL901	Brass / Iron	Cp - Mab - Gp - Black - Gray	Key	40 - 65
NL902	Brass / Iron	Cp - Mab - Gp - Black - Gray	W.c	40 - 65
NL903	Brass / Iron	Cp - Mab - Gp - Black - Gray	Switch	40 - 65

Castor Wheels

Focus on Quality



Cator Wheel

N75



چرخ صنعتی ۷۵ ساده و ترمزدار

Code	Material	Type	size (mm)
N75	Steel / Plastic	No Break	75
N75B	Steel / Plastic	Break	75

N50



چرخ صنعتی ۵۰ ساده و ترمزدار

Code	Material	Type	size (mm)
N71	Steel / Plastic	No Break	50
N71B	Steel / Plastic	Break	50

N30



چرخ ثابت ۳۰

Material	Steel / Plastic
size (mm)	30
Type	No Break
Colour	Black / White / Grey

Connecting Fittings

Focus on Quality



Connecting Fitting

F16-40



زیر سری بیضی

Material	AL
Colour	Cp / Mab / Gp
size (mm)	19

N520



زیر سری رزوه‌ای

Material	Zamak
Colour	Cp / Mab / Gp
size (mm)	25

F25N



زیر سری نیم‌گرد

Material	AL
Colour	Cp / Mab / Gp
size (mm)	25

F16



بست دیواری ثابت

Material	AL
Colour	Cp / Mab / Gp
size (mm)	19

Connecting Fitting

N503



بست سقفی گرد ثابت

Material	AL
Colour	Multi Colour
Height (mm)	85
Diameter (mm)	25

FO25T



بست سقفی گرد تنظیمی

Material	Zinc
Colour	Cp / AB / Gp
Height (mm)	75 - 95
Diameter (mm)	25

FO25B



بست سقفی بیضی تنظیمی

Material	Zinc
Colour	Cp / AB / Gp
Height (mm)	75 - 95
Diameter (mm)	16

Connecting Fitting

N60 / N80



جا کابلی فلزی

Material	Zinc
Colour	Cp / Mab / Gp
Size (mm)	D: 60 / D: 80

GH10 / GH16



بست آتاژور لبه دار

Material	AL / Zinc
Colour	Cp / Mab / Gp / SN
Size (mm)	10 \ 16

GH50



بست آتاژور فکی

Material	Plastic / Zinc
Colour	Cp / Black
Size	S / m / L

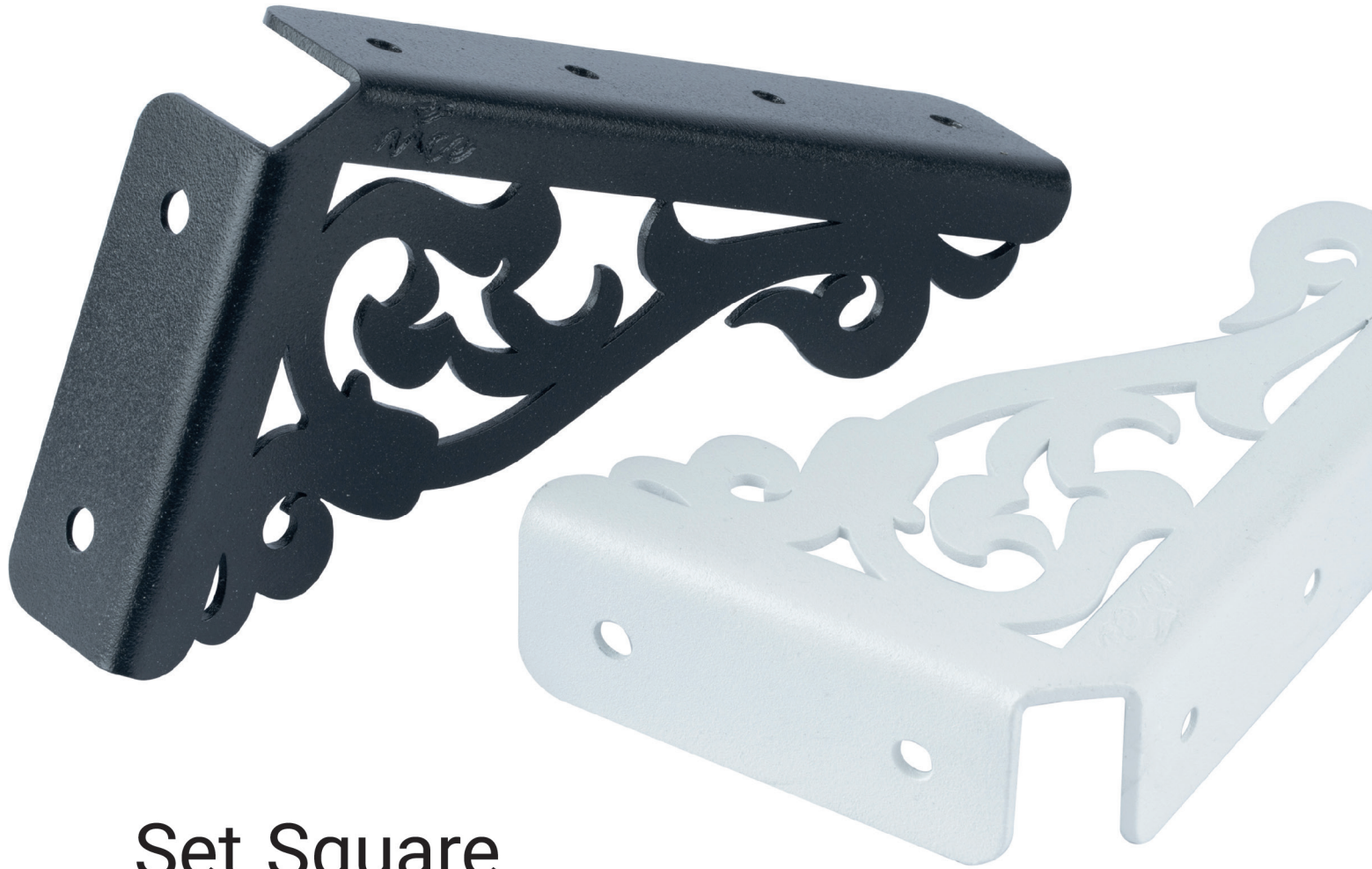

Set Square
Focus on Quality

Connecting Fitting

4510



گونیا تسمه‌ای وابنددار

Multi Colour



size (mm)	Length (mm)	Width (mm)	Material
S	200	300	Steel
M	240	350	Steel
L	280	400	Steel
XL	320	450	Steel

4210



گونیا فرفوزه

Multi Colour



size (mm)	Length (mm)	Width (mm)	Material
S	150	90	Steel
M	210	125	Steel
L	270	160	Steel

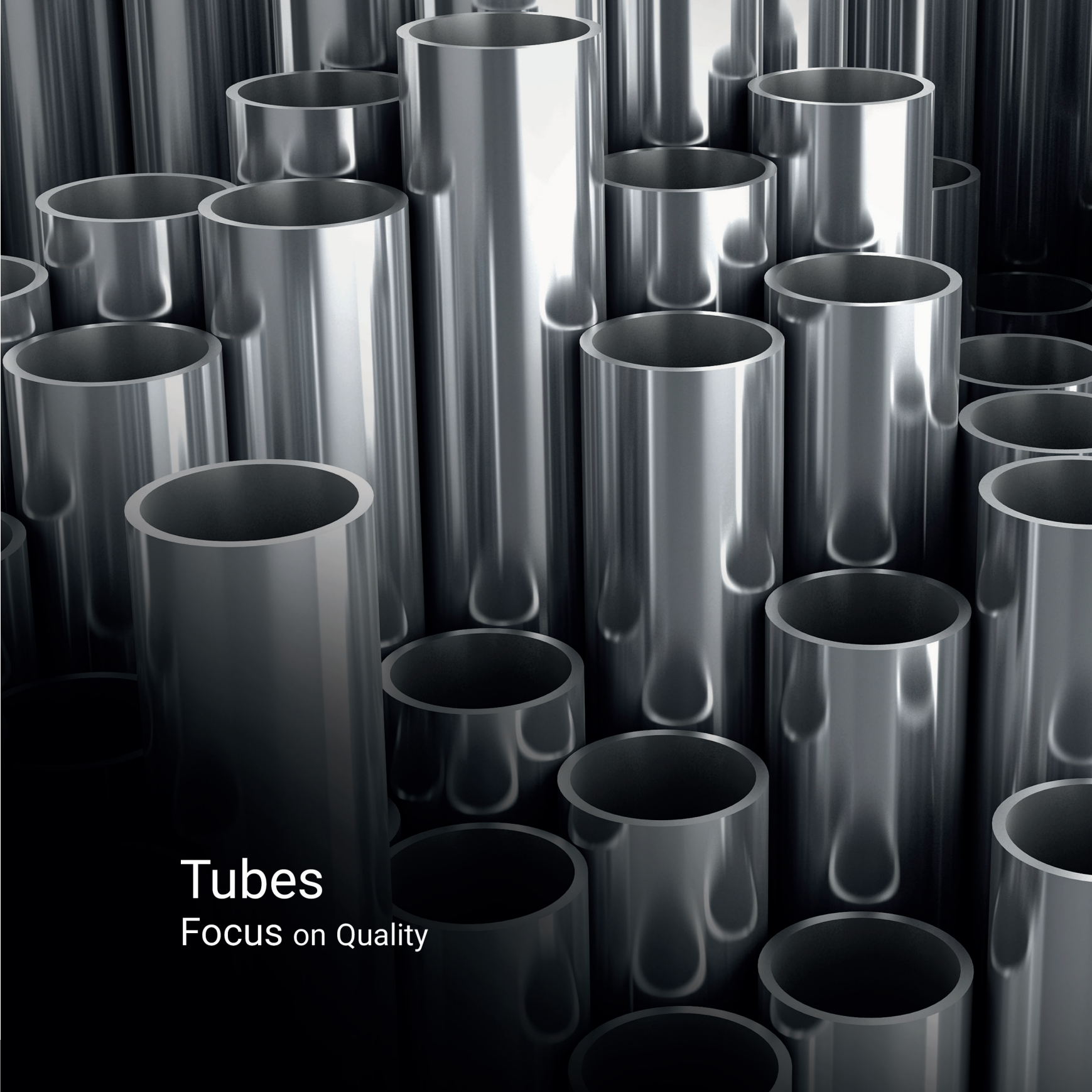

Tubes
Focus on Quality

لوله آهنی



Finish: Nickle Chrome / Black / White / Grey

Diameter (mm)	Length (mm)	Thickness
10	3000	4 - 5
16	3000	4 - 6
20	3000	5 - 6
22	3000	5 - 8
25	3000	6 - 8
32	3000	6 - 8
38	3000	6 - 8
42	3000	6 - 8
50	3000	6 - 8
60	3000	6 - 8

لوله استیل



Diameter (mm)	Length (mm)	Thickness
10	3000/6000	4
16	3000/6000	5
25	3000/6000	6
25 (Spiral Tube)	3000/6000	6
38	3000/6000	6
44.5	3000/6000	6
50	3000/6000	6
16 * 30	3000/6000	6

Dish Drainer

Focus on Quality



Dish Drainer

DH50

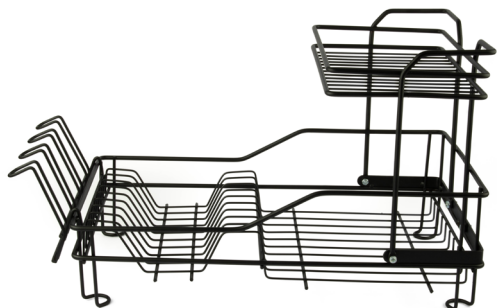

آبچک رومیزی دو طبقه

Size (Cm)	H (Cm)	Colour
30 * 50	30	Black-White

DH45

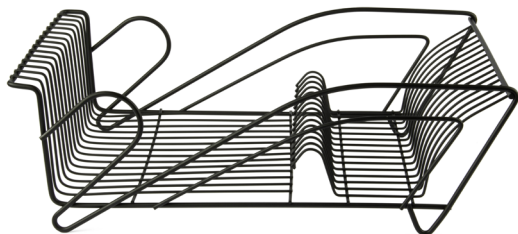

آبچک رومیزی یک طبقه

Size (Cm)	H (Cm)	Colour
33 * 44	15	Black-White

DH100



آبچک پشت پنجره‌ای

Size (Cm)	H (Cm)	Colour
100 * 120	66	Black-White

Dish Drainer



Size	Height (Cm)	Width	Cabinet Size (Cm)
76	9	24.5	80
86	9	24.5	90
96	9	24.5	100
116	9	24.5	120



Code	Name	Material	Colour
DH20	آبچک آبکاری	Steel	CP / White / Black
DH21	آبچک استیل	Stainless Steel	Steel

Dish Drainer

W-90

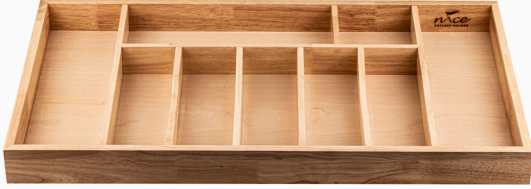

جا قاشق چنگالی چوبی

Real size (Cm)	Width (Cm)
40.5 * 80.5	45 * 90
45.5 * 80.5	50 * 90

K-90



جا قاشق چنگالی پلاستیکی

Real size (Cm)	Colour
50	Gray - White
60	
90	

125

www.nicehw.com



Electronic
Focus on Quality

Electronic

N2006



پریز توکار آسانسوری برقی

- یک پورت HDMI
- دو عدد سوکت برق
- یک عدد شارژر Type C
- یک عدد شارژر USB
- یک عدد پورت شبکه
- یک عدد شارژر وایرلس (بی سیم)
- به همراه کابل برق

H (mm) ارتفاع	400
D (mm) قطر	100

N2001



پریز توکار گردان برقی وایرلس دار

Multi Colour



- دو عدد سوکت برق
- یک پورت HDMI
- یک عدد شارژر Type C
- یک عدد شارژر USB
- یک عدد پورت شبکه
- یک عدد کلید قطع و وصل
- یک عدد شارژر وایرلس (بی سیم)
- به همراه کابل برق، شبکه و HDMI

H (mm) ارتفاع	105
D (mm) قطر	105
W (mm) عرض	430

N2007



پریز توکار آسانسوری

H (mm) ارتفاع	175
D (mm) قطر	90

- دو عدد سوکت برق
- دو عدد شارژر USB
- محافظ نوسان برق
- به همراه ۱/۵ متر کابل
- یک عدد پورت تلفن

N2002



پریز توکار گردان برقی

Multi Colour

H (mm) ارتفاع	105
L (mm) طول	350
W (mm) عرض	105

- دو عدد سوکت برق
- یک عدد پورت HDMI
- یک عدد پورت شبکه
- یک عدد شارژر Type C
- یک عدد شارژر USB
- یک عدد کلید قطع و وصل
- به همراه کابل برق، HDMI و شبکه

N2003



پریز توکار کشویی وایرلس دار

Multi Colour

H (mm) ارتفاع	50
L (mm) طول	340
W (mm) عرض	70

- دو عدد سوکت برق
- یک عدد پورت HDMI
- یک عدد پورت شبکه
- یک عدد شارژر Type C
- یک عدد شارژر USB
- یک عدد شارژر وایرلس (بی سیم)
- به همراه کابل برق

Electronic

N2004



پریز توکار داشبوردی

Multi Colour



H (mm) ارتفاع	65
L (mm) طول	225
W (mm) عرض	110

- یک عدد سوکت برق
- یک عدد شارژر Type C
- یک عدد شارژر USB
- یک عدد پورت HDMI
- یک عدد پورت شبکه
- یک عدد پورت تلفن
- به همراه کابل برق

N2005



پریز توکار درب لولایی

Multi Colour



H (mm) ارتفاع	80
L (mm) طول	170
W (mm) عرض	95

- یک عدد سوکت برق
- یک عدد شارژر Type C
- یک عدد شارژر USB
- یک عدد پورت HDMI
- یک عدد پورت شبکه
- به همراه کابل برق

N2021



شارژر وایرلس (بی سیم) توکار

D (mm) عمق	126
D (mm) قطر	80

- ورودی: 2A - 12V
- خروجی: 15W
- به همراه کابل برق



250

250 ml

approx. vol.

150

100



